

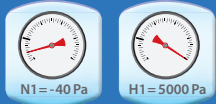

eka complex D

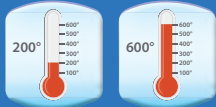

Price list, technical data
Double wall chimney system complex D
Wall thickness 0,6 mm, Insulation 25 mm



Liste de prix, données techniques
Cheminées double parois complex D
Paroi 0,6, Isolation thermique 25 mm



Listino prezzi, dati tecnici
Canne fumarie doppia parete complex D
Spessore 0,6 mm, Isolazione 25 mm



Prislijst
Doppelwandig systeem complex D
Wanddikte 0,6 mm, Isolatiedikte 25 mm



Прайс-Лист
Технические данные,
Двухстенная система
комплекс Д
толщина стенок 0,6 мм
теплоизоляция 25 мм

Doppelwandiges Schornsteinsystem

Isolierdicke 30 mm Ø 80 - 100 mm
Isolierdicke 25 mm ab Ø 113 mm

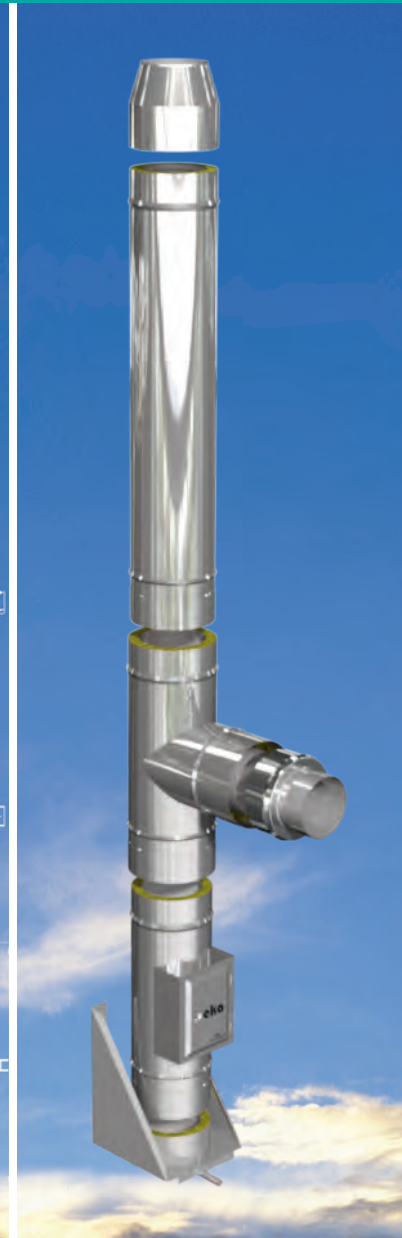
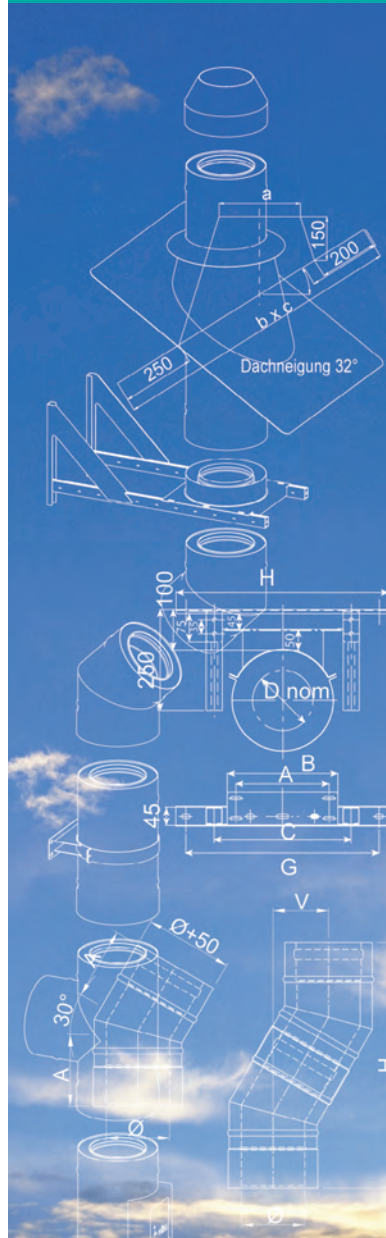

eka

A Sphering Company

Preisliste und technische Daten 2023
Technische Änderungen vorbehalten

Doppelwandiges Schornsteinsystem eka complex D

Isolierdicke 30 mm Ø 80 - 100 mm
Isolierdicke 25 mm ab Ø 113 mm



Wandkonsole 50mm		Technische Daten		Lg*	Preis	2250-Ø-WK	
		Ø d	a	b	kg	EUR	wall support console murale coppia alette wandconsole Настенная консоль
		80	232	365	-	58,90	
		100	260	365	-	62,20	
		113	260	375	-	62,20	
		130	260	375	-	62,20	
		150	280	385	-	64,80	
		160	310	400	-	72,80	
		180	310	400	-	72,80	
		200	330	430	-	81,60	
		250	380	480	-	105,60	
		300	430	535	-	116,20	
		350	480	590	-	146,20	
		400	530	620	-	153,50	
450	580	650	-	169,50			
500	650	680	-	202,90			

Wandkonsole verstellbar 50 - 90 mm		Technische Daten		Lg*	Preis	2250-Ø-WKV5	
		Ø d	a	b	kg	EUR	wall support extension 50 - 90 mm adjustable support mural réglable 50 - 90 mm supporto intermedio regolabile 50 - 90 mm Wandconsole verstellbar 50 - 90 mm Настенная консоль раздвижная 50-90 мм
		80	272	365	-	88,30	
		100	300	365	-	88,30	
		113	300	375	-	93,10	
		130	300	375	-	93,10	
		150	320	385	-	97,20	
		160	340	400	-	105,20	
		180	350	400	-	109,20	
		200	370	430	-	122,30	
		250	420	480	-	158,30	
		300	470	535	-	174,20	
		350	520	590	-	211,70	
		400	570	620	-	214,30	
450	620	650	-	217,60			
500	690	680	-	228,80			

Wandkonsolenverlängerung, starr 100 mm Wandkonsolenverlängerung, starr 150 mm		Technische Daten		Preis		2250-Ø-WKS10 2250-Ø-WKS15		
		WKS10	WKS15	WKS10	WKS15			
		Ø d	b	a	a	EUR	EUR	wall support extension 100/150 mm rigid rallonge support mural 100/150 mm prolunga per mensola rigida 100/150 mm wandconsole verlengung star 100/150 mm Удлиняющий элемент настенной консоли 100/150мм
		80	365	100	150	60,20	62,20	
		100	365	100	150	60,20	62,20	
		113	365	100	150	60,20	62,20	
		130	375	100	150	64,30	68,10	
		150	385	100	150	67,50	74,80	
		160	400	100	150	70,70	81,60	
		180	400	100	150	70,70	81,60	
		200	430	100	150	74,80	87,40	
		250	480	100	150	81,60	94,80	
		300	535	100	150	88,90	103,40	
		350	590	100	150	94,20	110,80	
		400	620	100	150	94,20	110,80	
450	650	100	150	106,90	124,20			
500	680	100	150	112,00	129,90			

Wandkonsole verstellbar, 50 - 150 mm		Technische Daten		Lg*	Preis	2250-Ø-WKV15
		Ø d	a	kg	EUR	wall support extension 100/150 mm rigid rallonge support mural 100/150 mm prolunga per mensola rigida 100/150 mm wandconsole verlengung star 100/150 mm Удлиняющий элемент настенной консоли 100/150мм
		80	380	-	110,80	
		100	380	-	110,80	
		113	380	-	110,80	
		130	380	-	110,80	
		150	380	-	110,80	
		160	480	-	132,80	
		180	480	-	132,80	
		200	480	-	132,80	
		250	480	-	132,80	

*Lg=Legierungsgewicht: Lg (in kg) x Faktor Legierungszuschlag (in €/kg) = Netto-Aufpreis Legierungszuschlag

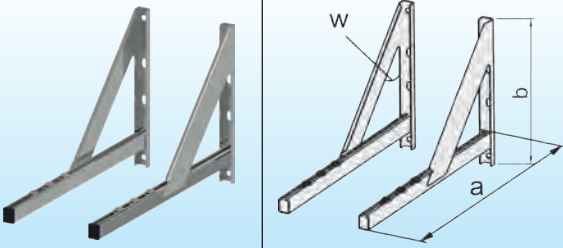
Wandkonsole, verstellbar 50 - 250 mm	Technische Daten	Lg*	Preis	2250-Ø-WKV (K)																																																																																										
 <p>Achtung: Bei Montage der Konsolen mit Schenkel nach unten, wird zur Montage der Bodenplatten ein Satz Wandkonsolenadapter WKA benötigt.</p>	<table border="1"> <thead> <tr> <th>Ø d</th> <th>a</th> <th>b</th> <th>W</th> <th>kg</th> <th>EUR</th> </tr> </thead> <tbody> <tr><td>80</td><td>550</td><td>400</td><td>34°</td><td>-</td><td>163,50</td></tr> <tr><td>100</td><td>550</td><td>400</td><td>34°</td><td>-</td><td>163,50</td></tr> <tr><td>113</td><td>550</td><td>400</td><td>34°</td><td>-</td><td>163,50</td></tr> <tr><td>130</td><td>550</td><td>400</td><td>34°</td><td>-</td><td>163,50</td></tr> <tr><td>150</td><td>550</td><td>400</td><td>34°</td><td>-</td><td>163,50</td></tr> <tr><td>160</td><td>550</td><td>400</td><td>34°</td><td>-</td><td>163,50</td></tr> <tr><td>180</td><td>550</td><td>400</td><td>34°</td><td>-</td><td>163,50</td></tr> <tr><td>200</td><td>550</td><td>400</td><td>34°</td><td>-</td><td>163,50</td></tr> <tr><td>250</td><td>650</td><td>400</td><td>34°</td><td>-</td><td>177,00</td></tr> <tr><td>300</td><td>650</td><td>400</td><td>34°</td><td>-</td><td>177,00</td></tr> <tr><td>350</td><td>800</td><td>400</td><td>45°</td><td>-</td><td>198,20</td></tr> <tr><td>400</td><td>800</td><td>400</td><td>45°</td><td>-</td><td>198,20</td></tr> <tr><td>450</td><td>800</td><td>400</td><td>45°</td><td>-</td><td>198,20</td></tr> <tr><td>500</td><td>1050</td><td>500</td><td>45°</td><td>-</td><td>277,60</td></tr> </tbody> </table>	Ø d	a	b	W	kg	EUR	80	550	400	34°	-	163,50	100	550	400	34°	-	163,50	113	550	400	34°	-	163,50	130	550	400	34°	-	163,50	150	550	400	34°	-	163,50	160	550	400	34°	-	163,50	180	550	400	34°	-	163,50	200	550	400	34°	-	163,50	250	650	400	34°	-	177,00	300	650	400	34°	-	177,00	350	800	400	45°	-	198,20	400	800	400	45°	-	198,20	450	800	400	45°	-	198,20	500	1050	500	45°	-	277,60			<ul style="list-style-type: none"> wall support extension 50 - 250 mm adjustable support mural réglable 50 - 250 mm supporto intermedio regolabile 50 - 250 mm wandconsole verlenging, verstelbaar 50-250 mm Настенная консоль раздвижная 50 - 250 мм
	Ø d	a	b	W	kg	EUR																																																																																								
	80	550	400	34°	-	163,50																																																																																								
	100	550	400	34°	-	163,50																																																																																								
	113	550	400	34°	-	163,50																																																																																								
	130	550	400	34°	-	163,50																																																																																								
	150	550	400	34°	-	163,50																																																																																								
	160	550	400	34°	-	163,50																																																																																								
	180	550	400	34°	-	163,50																																																																																								
	200	550	400	34°	-	163,50																																																																																								
	250	650	400	34°	-	177,00																																																																																								
	300	650	400	34°	-	177,00																																																																																								
	350	800	400	45°	-	198,20																																																																																								
400	800	400	45°	-	198,20																																																																																									
450	800	400	45°	-	198,20																																																																																									
500	1050	500	45°	-	277,60																																																																																									

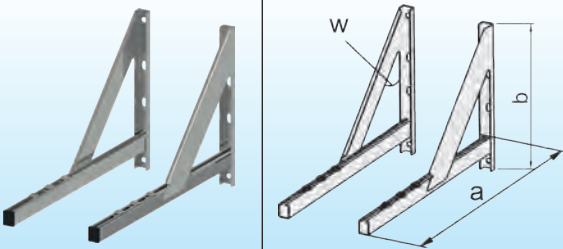
Wandkonsole, verstellbar 50-500 mm	Technische Daten	Lg*	Preis	2250-Ø-WKV (L)																																																																																										
 <p>Achtung: Bei Montage der Konsolen mit Schenkel nach unten, wird zur Montage der Bodenplatten ein Satz Wandkonsolenadapter WKA benötigt.</p>	<table border="1"> <thead> <tr> <th>Ø d</th> <th>a</th> <th>b</th> <th>W</th> <th>kg</th> <th>EUR</th> </tr> </thead> <tbody> <tr><td>80</td><td>800</td><td>400</td><td>34°</td><td>-</td><td>192,20</td></tr> <tr><td>100</td><td>800</td><td>400</td><td>34°</td><td>-</td><td>192,20</td></tr> <tr><td>113</td><td>800</td><td>400</td><td>34°</td><td>-</td><td>192,20</td></tr> <tr><td>130</td><td>800</td><td>400</td><td>34°</td><td>-</td><td>192,20</td></tr> <tr><td>150</td><td>800</td><td>400</td><td>34°</td><td>-</td><td>192,20</td></tr> <tr><td>160</td><td>800</td><td>400</td><td>34°</td><td>-</td><td>192,20</td></tr> <tr><td>180</td><td>800</td><td>400</td><td>34°</td><td>-</td><td>192,20</td></tr> <tr><td>200</td><td>800</td><td>400</td><td>34°</td><td>-</td><td>192,20</td></tr> <tr><td>250</td><td>900</td><td>500</td><td>45°</td><td>-</td><td>232,80</td></tr> <tr><td>300</td><td>900</td><td>500</td><td>45°</td><td>-</td><td>232,80</td></tr> <tr><td>350</td><td>1050</td><td>500</td><td>45°</td><td>-</td><td>277,60</td></tr> <tr><td>400</td><td>1050</td><td>500</td><td>45°</td><td>-</td><td>277,60</td></tr> <tr><td>450</td><td>1050</td><td>500</td><td>45°</td><td>-</td><td>277,60</td></tr> <tr><td>500</td><td>1250</td><td>500</td><td>45°</td><td>-</td><td>294,30</td></tr> </tbody> </table>	Ø d	a	b	W	kg	EUR	80	800	400	34°	-	192,20	100	800	400	34°	-	192,20	113	800	400	34°	-	192,20	130	800	400	34°	-	192,20	150	800	400	34°	-	192,20	160	800	400	34°	-	192,20	180	800	400	34°	-	192,20	200	800	400	34°	-	192,20	250	900	500	45°	-	232,80	300	900	500	45°	-	232,80	350	1050	500	45°	-	277,60	400	1050	500	45°	-	277,60	450	1050	500	45°	-	277,60	500	1250	500	45°	-	294,30			<ul style="list-style-type: none"> wall support extension 50 - 500 mm adjustable support mural réglable 50 - 500 mm supporto intermedio regolabile 50 - 500 mm wandconsole verlenging, verstelbaar 50 - 500 mm Настенная консоль раздвижная 50 - 500 мм
	Ø d	a	b	W	kg	EUR																																																																																								
	80	800	400	34°	-	192,20																																																																																								
	100	800	400	34°	-	192,20																																																																																								
	113	800	400	34°	-	192,20																																																																																								
	130	800	400	34°	-	192,20																																																																																								
	150	800	400	34°	-	192,20																																																																																								
	160	800	400	34°	-	192,20																																																																																								
	180	800	400	34°	-	192,20																																																																																								
	200	800	400	34°	-	192,20																																																																																								
	250	900	500	45°	-	232,80																																																																																								
	300	900	500	45°	-	232,80																																																																																								
	350	1050	500	45°	-	277,60																																																																																								
400	1050	500	45°	-	277,60																																																																																									
450	1050	500	45°	-	277,60																																																																																									
500	1250	500	45°	-	294,30																																																																																									

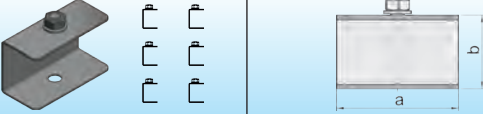
Wandkonsolenadapter (Satz = 6 Stück)	Technische Daten	Lg*	Preis	1000-000-WKA										
	<table border="1"> <thead> <tr> <th>Ø d</th> <th>a</th> <th>b</th> <th>kg</th> <th>EUR</th> </tr> </thead> <tbody> <tr> <td>-</td> <td>70</td> <td>42</td> <td>-</td> <td>49,80</td> </tr> </tbody> </table>	Ø d	a	b	kg	EUR	-	70	42	-	49,80			<ul style="list-style-type: none"> wall bracket adapter adaptateur de support mural murrbeugel adapter
	Ø d	a	b	kg	EUR									
-	70	42	-	49,80										
Max. Aufbauhöhe über Konsole bis NW 300 mm: 5 m, ab NW 350 mm: 2,5 m														

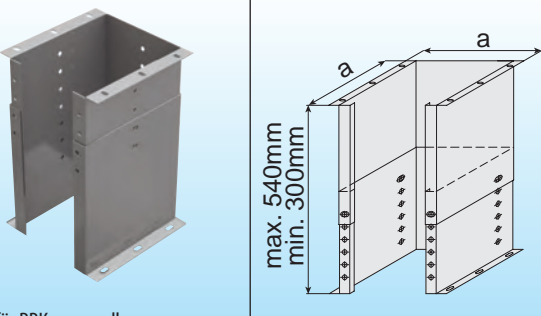
Sockelelement, verstellbar	Technische Daten	Lg*	Preis	2250-Ø-SV																																																																											
 <p>nur für BPK verwendbar</p>	<table border="1"> <thead> <tr> <th>Ø d</th> <th>a</th> <th>b</th> <th>kg</th> <th>EUR</th> </tr> </thead> <tbody> <tr><td>80</td><td>220</td><td>-</td><td>-</td><td>187,30</td></tr> <tr><td>100</td><td>240</td><td>-</td><td>-</td><td>200,60</td></tr> <tr><td>113</td><td>240</td><td>-</td><td>-</td><td>200,60</td></tr> <tr><td>130</td><td>240</td><td>-</td><td>-</td><td>200,60</td></tr> <tr><td>150</td><td>260</td><td>-</td><td>-</td><td>210,00</td></tr> <tr><td>160</td><td>290</td><td>-</td><td>-</td><td>248,90</td></tr> <tr><td>180</td><td>290</td><td>-</td><td>-</td><td>248,90</td></tr> <tr><td>200</td><td>310</td><td>-</td><td>-</td><td>262,20</td></tr> <tr><td>250</td><td>360</td><td>-</td><td>-</td><td>294,80</td></tr> <tr><td>300</td><td>410</td><td>-</td><td>-</td><td>328,40</td></tr> <tr><td>350</td><td>460</td><td>-</td><td>-</td><td>361,10</td></tr> <tr><td>400</td><td>510</td><td>-</td><td>-</td><td>377,90</td></tr> <tr><td>450</td><td>560</td><td>-</td><td>-</td><td>410,70</td></tr> <tr><td>500</td><td>610</td><td>-</td><td>-</td><td>442,60</td></tr> </tbody> </table>	Ø d	a	b	kg	EUR	80	220	-	-	187,30	100	240	-	-	200,60	113	240	-	-	200,60	130	240	-	-	200,60	150	260	-	-	210,00	160	290	-	-	248,90	180	290	-	-	248,90	200	310	-	-	262,20	250	360	-	-	294,80	300	410	-	-	328,40	350	460	-	-	361,10	400	510	-	-	377,90	450	560	-	-	410,70	500	610	-	-	442,60			<ul style="list-style-type: none"> basic element adjustable socle réglable, pour conduit base regolabile voetstukelement verstelbaar Цокольный элемент регулируемый
	Ø d	a	b	kg	EUR																																																																										
	80	220	-	-	187,30																																																																										
	100	240	-	-	200,60																																																																										
	113	240	-	-	200,60																																																																										
	130	240	-	-	200,60																																																																										
	150	260	-	-	210,00																																																																										
	160	290	-	-	248,90																																																																										
	180	290	-	-	248,90																																																																										
	200	310	-	-	262,20																																																																										
	250	360	-	-	294,80																																																																										
	300	410	-	-	328,40																																																																										
	350	460	-	-	361,10																																																																										
400	510	-	-	377,90																																																																											
450	560	-	-	410,70																																																																											
500	610	-	-	442,60																																																																											

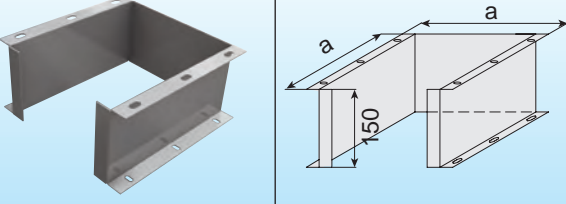
Sockelelement, starr	Technische Daten	Lg*	Preis	2250-Ø-SST																																																																											
 <p>nur für BPK verwendbar</p>	<table border="1"> <thead> <tr> <th>Ø d</th> <th>a</th> <th>b</th> <th>kg</th> <th>EUR</th> </tr> </thead> <tbody> <tr><td>80</td><td>220</td><td>-</td><td>-</td><td>83,10</td></tr> <tr><td>100</td><td>240</td><td>-</td><td>-</td><td>83,10</td></tr> <tr><td>113</td><td>240</td><td>-</td><td>-</td><td>83,10</td></tr> <tr><td>130</td><td>240</td><td>-</td><td>-</td><td>83,10</td></tr> <tr><td>150</td><td>260</td><td>-</td><td>-</td><td>88,90</td></tr> <tr><td>160</td><td>290</td><td>-</td><td>-</td><td>88,90</td></tr> <tr><td>180</td><td>290</td><td>-</td><td>-</td><td>88,90</td></tr> <tr><td>200</td><td>310</td><td>-</td><td>-</td><td>93,60</td></tr> <tr><td>250</td><td>360</td><td>-</td><td>-</td><td>102,90</td></tr> <tr><td>300</td><td>410</td><td>-</td><td>-</td><td>112,90</td></tr> <tr><td>350</td><td>460</td><td>-</td><td>-</td><td>123,50</td></tr> <tr><td>400</td><td>510</td><td>-</td><td>-</td><td>128,00</td></tr> <tr><td>450</td><td>560</td><td>-</td><td>-</td><td>138,20</td></tr> <tr><td>500</td><td>610</td><td>-</td><td>-</td><td>147,30</td></tr> </tbody> </table>	Ø d	a	b	kg	EUR	80	220	-	-	83,10	100	240	-	-	83,10	113	240	-	-	83,10	130	240	-	-	83,10	150	260	-	-	88,90	160	290	-	-	88,90	180	290	-	-	88,90	200	310	-	-	93,60	250	360	-	-	102,90	300	410	-	-	112,90	350	460	-	-	123,50	400	510	-	-	128,00	450	560	-	-	138,20	500	610	-	-	147,30			<ul style="list-style-type: none"> foundation-element, non-variable socle fixe base fissa voetstukelement star Цокольный элемент не регулируемый
	Ø d	a	b	kg	EUR																																																																										
	80	220	-	-	83,10																																																																										
	100	240	-	-	83,10																																																																										
	113	240	-	-	83,10																																																																										
	130	240	-	-	83,10																																																																										
	150	260	-	-	88,90																																																																										
	160	290	-	-	88,90																																																																										
	180	290	-	-	88,90																																																																										
	200	310	-	-	93,60																																																																										
	250	360	-	-	102,90																																																																										
	300	410	-	-	112,90																																																																										
	350	460	-	-	123,50																																																																										
400	510	-	-	128,00																																																																											
450	560	-	-	138,20																																																																											
500	610	-	-	147,30																																																																											

*Lg=Legierungsgewicht: Lg (in kg) x Faktor Legierungszuschlag (in €/kg) = Netto-Aufpreis Legierungszuschlag

Doppelwandiges Schornsteinsystem eka complex D

Isolierdicke 30 mm Ø 80 - 100 mm
Isolierdicke 25 mm ab Ø 113 mm



Bodenplatte mit Kondensatablauf, runde Sockelausführung		Technische Daten		Lg*	Preis	2250-Ø-BPKR
<p>Sonderausführung mit Ablauf senkrecht und Klappdeckel Standfuß möglich. Aufpreis: 30 €</p>	Ød	ØD	Øa	kg	EUR	<ul style="list-style-type: none"> bottom plate with round basic element, 1000 mm, cutable socle rond pour conduit, 1000 mm, ajustable piedistallo di partenza rotondo isolato, 1000 mm, accorciabile bodemplaat met ronde voetstukuitvoering, 1000 mm hoogte Напольная плита с конденсатоотводом
	80	140	210	0,95	189,70	
	100	163	230	1,13	195,40	
	113	163	233	1,21	196,90	
	130	180	250	1,37	199,60	
	150	200	270	1,56	206,20	
	160	213	283	1,66	212,90	
	180	230	300	1,85	219,60	
	200	250	320	2,05	226,30	
	250	300	370	2,56	253,00	
	300	350	420	3,08	278,90	
	350	400	470	3,63	292,30	
400	450	520	4,19	317,30		
450	500	570	4,77	342,20		
500	550	620	5,37	367,10		

Bodenplatte Sockelausführung		Technische Daten		Lg*	Preis	2250-Ø-BKSO	
<p>b Achsmaß Bohrflöcher</p>	Ød	ØD	a	b	kg	EUR	<ul style="list-style-type: none"> basic plate with drain, 60 mm high plaque de base, 60 mm Piastra di partenza con scario di condensa altezza 60 mm bodemplaat met condensafvoer voetstukuitv. 60 mm hoogte Напольная плита в цокольном исполнении с конденсатоотводом
	80	140	220	250	1,48	69,00	
	100	163	240	270	1,69	71,40	
	113	163	220	280	1,69	72,80	
	130	180	240	300	1,69	72,80	
	150	200	260	320	1,91	72,80	
	160	213	273	335	2,27	72,80	
	180	230	290	350	2,27	77,50	
	200	250	310	370	2,53	88,30	
	250	300	360	420	3,23	100,80	
	300	350	410	470	4,00	117,60	
	350	400	460	520	4,86	127,30	
400	450	510	570	5,79	153,00		
450	500	500	620	6,81	176,60		
500	550	510	670	7,91	202,90		

Bodenplatte mit Kondensatablauf		Technische Daten		Lg*	Preis	2250-Ø-BPK	
<p>b Achsmaß Bohrflöcher</p>	Ød	ØD	a	b	kg	EUR	<ul style="list-style-type: none"> bottom plate with drain plaque de base piastra di partenza con raccogli condensa bodemplaat voor tussensteunen Напольная плита с конденсатоотводом
	80	140	220	195	1,11	52,90	
	100	163	240	215	1,21	54,20	
	113	163	240	215	1,21	55,40	
	130	180	240	215	1,39	58,10	
	150	200	260	235	1,61	60,20	
	160	213	290	265	1,92	61,60	
	180	230	290	265	1,97	64,80	
	200	250	310	285	2,22	74,80	
	250	300	360	335	2,91	86,20	
	300	350	410	385	3,68	94,80	
	350	400	460	435	4,52	101,80	
400	450	510	485	5,45	122,20		
450	500	560	535	6,46	141,40		
500	550	610	585	7,55	163,20		

Bodenplatte geschlossen für FB87		Technische Daten		Lg*	Preis	2250-Ø-BPGFB	
<p>b Achsmaß Bohrflöcher</p>	Ød	ØD	a	b	kg	EUR	<ul style="list-style-type: none"> basic plate FB87 plaque de base, FB87 Piastra di partenza con scario, FB87 bodemplaat met condensafvoer, FB87 Напольная плита в цокольном, FB87
	80	140	220	195	1,11	52,90	
	100	163	240	215	1,21	54,20	
	113	163	240	215	1,21	55,40	
	130	180	240	215	1,39	58,10	
	150	200	260	235	1,61	60,20	
	160	213	290	265	1,92	61,60	
	180	230	290	265	1,97	64,80	
	200	250	310	285	2,22	74,80	
	250	300	360	335	2,91	86,20	
	300	350	410	385	3,68	94,80	
	350	400	460	435	4,52	101,80	
400	450	510	485	5,45	122,20		
450	500	560	535	6,46	141,40		
500	550	610	585	7,55	163,20		

*Lg=Legierungsgewicht: Lg (in kg) x Faktor Legierungszuschlag (in €/kg) = Netto-Aufpreis Legierungszuschlag

Bodenplatte für Zwischenstütze		Technische Daten	Lg*	Preis	2250-Ø-BPZ			
		Ø d	Ø D	a	b	kg	EUR	intermediate plate
	80	140	220	195	0,93	41,50	plaque de base intermédiaire	
	100	163	240	215	1,00	42,60	piastra di partenza con raccogli condensa	
	113	163	240	215	1,05	43,50	bodenplaat voor tussensteunen	
	130	180	240	215	1,18	44,80	Напольная плита для промежуточной опоры	
	150	200	260	235	1,33	45,50		
	160	213	290	265	1,56	46,30		
	180	230	290	265	1,60	46,80		
	200	250	310	285	1,72	50,20		
	250	300	360	335	2,12	82,10		
	300	350	410	385	2,55	90,90		
	350	400	460	435	2,99	104,30		
	400	450	510	485	3,44	126,00		
450	500	560	535	3,92	142,70			
500	550	610	585	4,41	177,80			

Bodenplatte für Zwischenstütze mit Klemmbandstützen		Technische Daten	Lg*	Preis	2250-Ø-BPZK		
		Ø d	Ø D	a	kg	EUR	intermediate plate with locking band
	80	140	220	1,83	69,50	plaque de base intermédiaire avec cannelure pour colliers de fixation	
	100	163	240	1,95	69,50	Base con fascietta a bocchettone	
	113	163	240	2,02	69,50	bodenplaat voor tussensteunen met klembandsteun	
	130	180	240	2,10	71,70	Напольная плита с держателями для хомута	
	150	200	260	2,36	72,70		
	160	213	290	2,69	73,90		
	180	230	290	2,76	74,80		
	200	250	310	3,03	80,30		
	250	300	360	3,72	131,50		
	300	350	410	4,42	145,30		
	350	400	460	5,14	166,80		
	400	450	510	5,87	201,60		
450	500	560	6,63	228,30			
500	550	610	7,40	284,50			

Rußtopf		Technische Daten	Lg*	Preis	2250-Ø-RT 2250-Ø-RTDW	
		Ø d	kg	Typ RT EUR	Typ RTDW EUR	condensate collector
	80	0,13	24,40	36,50	pot à condensat pour BPZ y compris fixations	
	100	0,16	25,10	37,70	tappo con spurgo	
	113	0,18	25,60	38,40	Roetpot	
	130	0,22	27,50	41,20	Сажесборник	
	150	0,27	30,10	45,10		
	160	0,29	31,50	47,30		
	180	0,34	32,90	49,30		
	200	0,39	33,50	50,20		
	250	0,54	39,40	59,20		
	300	0,70	89,60	112,10		
	350	0,88	94,10	117,70		
	400	1,09	99,50	124,40		
450	1,31	105,50	131,90			
500	1,54	113,00	141,30			

Typ RT passend für BPZ
Typ RTDW passend für DW-Bauteile

Prüföffnung Hochtemperatur		Technische Daten	Lg*	Preis	2250-Ø-PHDW			
		Ø d	Ø D	a	b	kg	EUR	inspection length, high temperature
	100	163	600	105	3,65	265,50	élément d'inspection haute température	
	113	163	600	115	3,80	265,50	elemento di ispezione per alta temperatura	
	130	180	600	125	4,10	274,10	inspectie-opening hoge temperatuur	
	150	200	600	135	4,47	291,40	Окошко для осмотра, высокие температуры	
	160	213	600	142	4,67	304,80		
	180	230	600	150	5,01	318,20		
	200	250	600	160	5,37	344,70		
	250	300	600	185	6,27	386,80		
	300	350	600	210	7,18	421,60		
	350	400	650	235	8,08	441,90		
	400	450	650	260	8,99	480,90		
	450	500	650	285	9,89	669,70		
500	550	650	310	10,80	757,30			

Reinigungsöffnung bis Nennweite 300 mm: Größe 120x180 mm / Reinigungsöffnung ab Nennweite 350 mm: Größe 200x300 mm

*Lg=Legierungsgewicht: Lg (in kg) x Faktor Legierungszuschlag (in €/kg) = Netto-Aufpreis Legierungszuschlag

Doppelwandiges Schornsteinsystem eka complex D

Isolierdicke 30 mm Ø 80 - 100 mm
Isolierdicke 25 mm ab Ø 113 mm



Prüföffnung Niedertemperatur		Technische Daten		Lg*	Preis	2250-Ø-PNDW
		Ø d	Ø D	kg	EUR	<ul style="list-style-type: none"> inspection length, low temperature élément d'inspection basse température elemento di ispezione basse temperature isolato inspectie opening lage temperatuur Окошко для осмотра низкие температуры
		80	140	1,94	284,90	
		100	163	2,30	284,90	
		113	163	2,45	286,70	
		130	180	2,75	295,50	
		150	200	3,12	314,80	
		160	213	3,32	329,50	
		180	230	3,66	343,50	
		200	250	4,02	372,70	
		250	300	4,92	418,10	
		300	350	5,83	454,80	
		350	400	6,73	477,10	
400	450	7,64	626,20			
450	500	8,54	723,20			
500	550	9,45	817,70			

Prüföffnung mit Überströmöffnung		Technische Daten		Lg*	Preis	2250-Ø-PÜ
		Ø d	Ø D	kg	EUR	<ul style="list-style-type: none"> inspection LAS with air grill élément d'inspection LAS température elemento di ispezione con apertura di scarico LAS isolato inspectie opening met trekregelaar Окошко для осмотра с отверстием для перетечения
		113	163	2,45	286,70	
		130	180	2,75	295,50	
		150	200	3,12	314,80	
		160	213	3,32	329,50	
		180	230	3,66	343,50	
		200	250	4,02	372,70	
		250	300	4,92	418,10	
		300	350	5,83	454,80	
		350	400	6,73	477,10	
		400	450	7,64	626,20	
		450	500	8,54	723,20	
500	550	9,45	817,70			

Reinigungsöffnung mit Klappdeckel und Vitondichtung, max. 200°C		Technische Daten			Lg*	Preis	2250-Ø-LSKDVIT
		Ø d	Ø D	Ø a	kg	EUR	<ul style="list-style-type: none"> inspection length with sealant viton élément d'inspection avec trappe de visite - joint pour manchon viton elemento di ispezione con guarnizione viton inspectie opening met afdichtingsring viton Окошко для осмотра Уплотнительное кольцо витон
		80	140	80	1,79	134,90	
		100	163	100	2,12	139,10	
		113	163	100	2,25	139,10	
		130	180	130	2,52	142,30	
		150	200	150	2,85	161,80	
		160	213	150	3,04	168,40	
		180	230	180	3,34	175,10	
		200	250	200	3,66	185,70	
		250	300	220	4,48	220,30	
		300	350	220	5,29	250,40	

Reinigungsöffnung mit Klappdeckel und Isothermdichtung, max. 600°C		Technische Daten			Lg*	Preis	2250-Ø-LSKDISO
		Ø d	Ø D	Ø a	kg	EUR	<ul style="list-style-type: none"> inspection length with sealant isotherm élément d'inspection avec trappe de visite - joint pour manchon Isotherm elemento di ispezione con guarnizione isotherm inspectie opening met afdichtingsring Isotherm Окошко для осмотра Уплотнительное кольцо исотерм
		80	140	80	1,79	126,30	
		100	163	100	2,12	130,20	
		113	163	100	2,25	130,20	
		130	180	130	2,52	132,30	
		150	200	150	2,85	150,80	
		160	213	150	3,04	157,50	
		180	230	180	3,34	159,50	
		200	250	200	3,66	170,10	
		250	300	220	4,48	205,10	
		300	350	220	5,29	235,10	

*Lg=Legierungsgewicht: Lg (in kg) x Faktor Legierungszuschlag (in €/kg) = Netto-Aufpreis Legierungszuschlag

Doppelwandiges Schornsteinsystem eka complex D

Isolierdicke 30 mm Ø 80 - 100 mm
Isolierdicke 25 mm ab Ø 113 mm

Kombibauteil gegenüberliegend		Technische Daten		Lg*		Preis		2250-Ø-F90PH	
<p>Ø 80 + Ø 100 mit Klappdeckel.</p>		Ø d	Ø D	a	b	c	kg	EUR	<ul style="list-style-type: none"> combination part pièce combinée Elemento combinato aansluitstuk 90° gecombineerd Патрубок к газоходу с окошком для просмотра
		80	140	525	290	235	3,29	414,90	
		100	163	600	270	247	3,65	418,90	
		113	163	600	270	247	3,80	418,90	
		130	180	600	305	255	4,10	434,20	
		150	200	600	290	265	4,47	468,60	
		160	213	600	270	270	4,67	498,80	
		180	230	600	305	280	5,01	529,50	
		200	250	600	315	290	5,37	590,10	
		250	300	610	315	315	6,27	682,70	
		300	350	660	340	340	7,18	781,70	

Feuerungsanschluss 45°		Technische Daten		Lg*		Preis		2250-Ø-F45	
		Ø d	Ø D	a	b	c	kg	EUR	<ul style="list-style-type: none"> T-45°, isolated Té de Raccordement 45°, isolé T 45° isolato aansluitstuk 45° Патрубок 45° к газоходу
		80	140	525	334	334	2,12	172,40	
		100	163	550	361	361	2,65	178,10	
		113	163	550	361	361	2,85	184,10	
		130	180	560	382	382	3,31	214,70	
		150	200	600	406	406	4,02	247,40	
		160	213	610	419	419	4,39	264,70	
		180	230	630	443	443	5,04	269,40	
		200	250	660	467	467	5,81	318,20	
		250	300	730	527	527	7,96	384,20	
		300	350	800	588	588	10,50	474,80	
350	400	870	647	647	13,27	518,00			
400	450	940	707	707	16,33	797,70			
450	500	1020	768	768	19,85	931,60			
500	550	1090	828	828	23,38	1042,80			

Feuerungsanschluss 90° Hochtemperatur		Technische Daten		Lg*		Preis		2250-Ø-F90H	
		Ø d	Ø D	a	b	c	kg	EUR	<ul style="list-style-type: none"> T-90° high temperature T-90° haute température Raccordo a T 90° alta temperatura aansluitstuk 90° hoge temperatuur Патрубок 90° к газоходу для высоких температу
		80	140	525	290	235	2,16	149,50	
		100	163	600	270	247	2,59	153,40	
		113	163	600	270	247	2,99	153,40	
		130	180	600	305	255	3,38	160,20	
		150	200	600	290	265	3,84	177,40	
		160	213	600	270	270	4,09	194,00	
		180	230	600	305	280	4,53	211,40	
		200	250	600	315	290	5,01	245,50	
		250	300	610	315	315	6,21	296,10	
		300	350	660	340	340	7,86	360,20	
350	400	710	365	365	9,66	401,10			
400	450	810	410	390	12,26	486,80			
450	500	810	410	415	13,72	554,10			
500	550	860	435	440	15,97	635,90			

Feuerungsanschluss 90° Niedertemperatur		Technische Daten		Lg*		Preis		2250-Ø-F90N	
		Ø d	Ø D	a	b	c	kg	EUR	<ul style="list-style-type: none"> T-90° low temperature T-90° basse température Raccordo a T 90° bassa temperatura aansluitstuk 90° lage temperatuur Патрубок к газоходу 90° низкие температуры
		80	140	525	290	235	2,16	149,50	
		100	163	600	270	247	2,59	155,20	
		113	163	600	270	247	2,99	159,50	
		130	180	600	305	255	3,38	166,20	
		150	200	600	290	265	3,84	184,10	
		160	213	600	270	270	4,09	201,40	
		180	230	600	305	280	4,53	218,80	
		200	250	600	315	290	5,01	254,10	
		250	300	610	315	315	6,21	296,10	
		300	350	660	340	340	7,86	360,20	
350	400	710	365	365	9,66	401,10			
400	450	810	410	390	12,26	486,80			
450	500	810	410	415	13,72	554,10			
500	550	860	435	440	15,97	635,90			

*Lg=Legierungsgewicht: Lg (in kg) x Faktor Legierungszuschlag (in €/kg) = Netto-Aufpreis Legierungszuschlag

Doppelwandiges Schornsteinsystem eka complex D

Isolierdicke 30 mm Ø 80 - 100 mm
Isolierdicke 25 mm ab Ø 113 mm



Feuerungsanschluss 90° LAS

Technische Daten

Lg*

Preis

2250-Ø-F1L

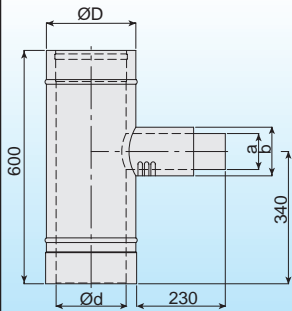

Maß a, b angeben

Ød	ØD	kg	EUR
113	163	2,95	159,50
130	180	3,26	166,20
150	200	3,62	184,10
160	213	3,83	201,40
180	230	4,16	218,80
200	250	4,52	254,10
250	300	5,43	296,10
300	350	6,33	360,20
350	400	7,23	401,10
400	450	8,14	486,80
450	500	9,04	554,10
500	550	9,95	635,90

- T-90° LAS
- T-90° LAS
- T-90° LAS
- T-90° LAS
- T-90° LAS

Feuerungsanschluss mit innenliegendem Bogen 87°

Technische Daten

Lg*

Preis

2250-Ø-FB87

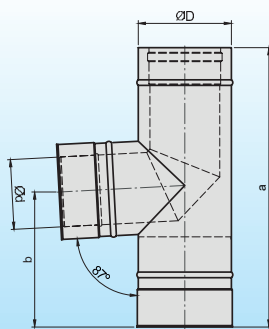

Ød	ØD	a	b	kg	EUR
80	140	525	290	2,16	185,60
100	163	600	270	2,62	191,30
113	163	600	270	3,75	191,30
130	180	600	305	3,90	199,60
150	200	600	290	4,38	220,90
160	213	600	270	4,62	241,70
180	230	600	305	5,10	262,60
200	250	600	290	5,59	305,00
250	300	610	315	6,82	355,30
300	350	660	340	8,07	432,20
350	400	710	365	9,66	481,30
400	450	810	390	12,26	584,20
450	500	810	415	13,72	637,30
500	550	860	440	15,97	731,30

- furnace-connector with internal elbow 87°
- Té de raccordement avec coude intégré de 87°
- Raccordo a T con curva interna 87°
- aansluitstuk met geïntegreerde bocht 87°
- Патрубок к газоходу с интегрированным отводом 87°

Übergangsstück DW /EW incl. Abdeckung Wärmedämmung EÜ

Technische Daten

Lg*

Preis

2250-Ø-EÜ

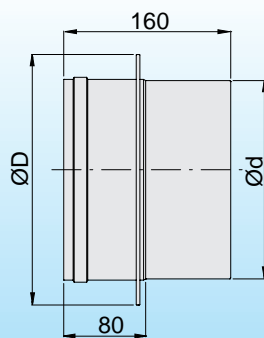

Aufpreis für Einbau Kugelfangkreuz:
bis DN200: 15 EUR; bis DN250: 30 EUR
EÜ anders herum: 25% Aufschlag

Ød	ØD	kg	EUR
80	140	0,22	40,30
100	163	0,27	41,00
113	163	0,31	41,50
130	180	0,35	42,90
150	200	0,41	46,30
160	213	0,43	47,50
180	230	0,49	50,20
200	250	0,60	54,80
250	300	0,75	61,60
300	350	0,90	65,50
350	400	1,06	70,40
400	450	1,21	80,10
450	500	1,36	92,80
500	550	1,51	99,80

- adapter with collar
- adaptateur avec collerette de recouvrement pour DP/SP
- adattatore isolato da doppia parete a monoparete
- overgangsstuk DW/EW incl. afdichting isolatie
- Переходник комплекс Д/ комплекс Е

Übergangsstück DW /EW incl. Abdeckung Wärmedämmung mit Wandfutter

Technische Daten

Lg*

Preis

2250-Ø-EÜWF

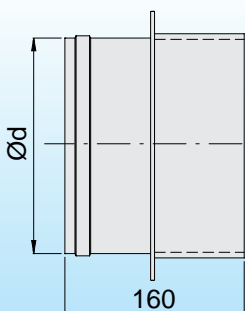
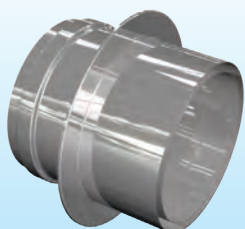



passend für Rauchrohr 2 mm

Ød	ØD	kg	EUR
80	140	0,83	53,20
100	163	0,96	54,90
113	163	1,05	54,90
130	180	1,16	56,40
150	200	1,30	60,90
160	213	1,36	62,80
180	230	1,50	66,30
200	250	1,63	71,50
250	300	1,96	78,90
300	350	2,29	83,50

- adapter CD/CE with double wall neck
- adaptateur DP/SP pour passage mural
- adattatore isolato da doppia parete a monoparete
- overgangsstuk DW/EW incl. afdichting isolatie met wanddoorvoering
- Переходник комплекс Д/ комплекс Е с кожухом теплоизоляции

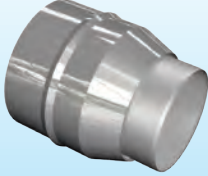
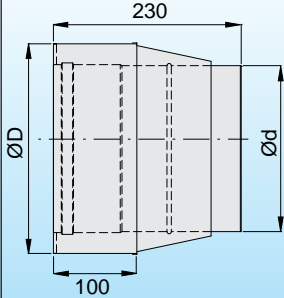
*Lg=Legierungsgewicht: Lg (in kg) x Faktor Legierungszuschlag (in €/kg) = Netto-Aufpreis Legierungszuschlag

Übergang DW /EW konisch		Technische Daten		Lg*	Preis	2250-Ø-EÜK
 	Ø d	Ø D		kg	EUR	adapter single/double wall conical
	80	140		0,96	60,30	adaptateur de recouvrement pour DP/SP conique
	100	163		1,10	62,20	adattatore conico per parete doppia/singolaisolato
	113	163		1,19	62,20	adaptatore conico per parete doppia/singolaisolato
	130	180		1,32	67,50	adaptatore conico per parete doppia/singolaisolato
	150	200		1,46	75,50	adaptatore conico per parete doppia/singolaisolato
	160	213		1,53	78,10	adaptatore conico per parete doppia/singolaisolato
	180	230		1,68	78,90	adaptatore conico per parete doppia/singolaisolato
	200	250		1,82	81,60	adaptatore conico per parete doppia/singolaisolato
	250	300		2,19	100,10	adaptatore conico per parete doppia/singolaisolato
	300	350		2,55	120,20	adaptatore conico per parete doppia/singolaisolato
	350	400		2,91	141,70	Переход комплекс Е/комплекс Д (конический)
	400	450		3,27	169,60	
450	500		3,63	195,30		
500	550		3,99	229,70		

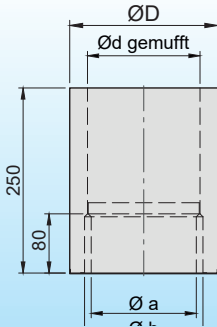
Längenelement 250 mm, kürzbar mit integriertem Wandfutter		Technische Daten		Lg*	Preis	2250-Ø-L3ETWF	
  <p>passend für Rauchrohr 2 mm</p>	Ø d	Ø D	a	b	kg	EUR	length, 250 mm, cuttable, with double wall neck
	80	140	72	90	0,78	84,10	élément droit 250 mm, ajustable pour passage mural
	100	163	92	110	0,82	87,10	Modulo lineare 250 mm accorciabile con isolamento senza manicotto
	113	163	108	123	0,86	87,10	schoorsteenelement 250 mm inkortbaar met geïntegreerde muurdoorvoer zonder mof
	130	180	122	140	0,98	91,50	schoorsteenelement 250 mm inkortbaar met geïntegreerde muurdoorvoer zonder mof
	150	200	142	160	1,10	100,70	schoorsteenelement 250 mm inkortbaar met geïntegreerde muurdoorvoer zonder mof
	160	213	152	170	1,21	108,00	schoorsteenelement 250 mm inkortbaar met geïntegreerde muurdoorvoer zonder mof
	180	230	172	190	1,29	116,20	schoorsteenelement 250 mm inkortbaar met geïntegreerde muurdoorvoer zonder mof
	200	250	192	210	1,42	123,60	schoorsteenelement 250 mm inkortbaar met geïntegreerde muurdoorvoer zonder mof
	250	300	242	260	1,73	150,40	отрезок трубы 250 мм у корачиваемый включая кожух теплоизоляции
	300	350	292	310	2,09	194,70	

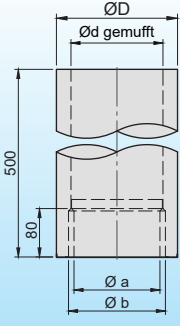
Längenelement 500 mm, kürzbar mit integriertem Wandfutter		Technische Daten		Lg*	Preis	2250-Ø-L5ETWF	
  <p>passend für Rauchrohr 2 mm</p>	Ø d	Ø D	a	b	kg	EUR	length, 500 mm, cuttable, with double wall neck
	80	140	72	90	1,48	104,90	élément droit 500 mm, ajustable pour passage mural
	100	163	92	110	1,64	107,90	elemento accorciabile con isolamento 500 mm
	113	163	108	123	1,92	107,90	verlengbuis 500 mm, inkortbaar met geïntegreerde wanddoor-voering zonder mof
	130	180	122	140	2,16	111,80	verlengbuis 500 mm, inkortbaar met geïntegreerde wanddoor-voering zonder mof
	150	200	142	160	2,44	122,80	verlengbuis 500 mm, inkortbaar met geïntegreerde wanddoor-voering zonder mof
	160	213	152	170	2,54	130,80	verlengbuis 500 mm, inkortbaar met geïntegreerde wanddoor-voering zonder mof
	180	230	172	190	2,87	138,80	verlengbuis 500 mm, inkortbaar met geïntegreerde wanddoor-voering zonder mof
	200	250	192	210	3,15	152,60	verlengbuis 500 mm, inkortbaar met geïntegreerde wanddoor-voering zonder mof
	250	300	242	260	3,85	188,80	отрезок трубы 500 мм у корачиваемый включая кожух теплоизоляции
	300	350	292	310	4,18	222,00	

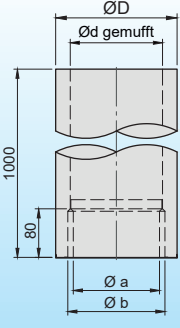
Längenelement 1000 mm, kürzbar mit integriertem Wandfutter		Technische Daten		Lg*	Preis	2250-Ø-L10ETWF	
  <p>passend für Rauchrohr 2 mm</p>	Ø d	Ø D	a	b	kg	EUR	length, 1000 mm, cuttable, with double wall neck
	80	140	72	90	2,86	147,50	élément droit 1000mm, ajustable pour passage mural
	100	163	92	110	3,36	150,50	elemento accorciabile con isolamento 1000 mm
	113	163	108	123	3,65	150,50	verlengbuis 1000 mm, inkortbaar met geïntegreerde wanddoor-voering zonder mof
	130	180	122	140	4,11	158,00	verlengbuis 1000 mm, inkortbaar met geïntegreerde wanddoor-voering zonder mof
	150	200	142	160	4,64	174,50	verlengbuis 1000 mm, inkortbaar met geïntegreerde wanddoor-voering zonder mof
	160	213	152	170	4,93	184,50	verlengbuis 1000 mm, inkortbaar met geïntegreerde wanddoor-voering zonder mof
	180	230	172	190	5,44	195,30	verlengbuis 1000 mm, inkortbaar met geïntegreerde wanddoor-voering zonder mof
	200	250	192	210	5,97	221,00	verlengbuis 1000 mm, inkortbaar met geïntegreerde wanddoor-voering zonder mof
	250	300	242	260	7,30	281,00	отрезок трубы 1000 мм у корачиваемый включая кожух теплоизоляции
	300	350	292	310	8,40	344,20	

*Lg=Legierungsgewicht: Lg (in kg) x Faktor Legierungszuschlag (in €/kg) = Netto-Aufpreis Legierungszuschlag

Doppelwandiges Schornsteinsystem eka complex D

Isolierdicke 30 mm Ø 80 - 100 mm
Isolierdicke 25 mm ab Ø 113 mm



Längenelement 1080 mm		Technische Daten		Lg*	Preis	2250-Ø-L10
		Ød	ØD	kg	EUR	length 1080 mm élément droit 1080 mm modulo lineare L=1080 mm schosteenelement L=1080 mm Труба 1080 мм
		80	140	3,58	113,90	
		100	163	4,23	117,40	
		113	163	4,49	119,40	
		130	180	5,05	126,80	
		150	200	5,70	141,30	
		160	213	6,07	151,20	
		180	230	6,67	160,10	
		200	250	7,32	184,80	
		250	300	8,95	246,70	
		300	350	10,58	300,80	
		350	400	12,21	388,30	
400	450	13,84	454,10			
450	500	15,46	466,70			
500	550	17,09	503,40			

Längenelement 540 mm		Technische Daten		Lg*	Preis	2250-Ø-L5
		Ød	ØD	kg	EUR	length 540 mm élément droit 540 mm modulo lineare L=540 mm schosteenelement L=540 mm Труба 540 мм
		80	140	1,79	67,70	
		100	163	2,12	69,20	
		113	163	2,25	70,10	
		130	180	2,52	73,40	
		150	200	2,85	81,40	
		160	213	3,04	87,90	
		180	230	3,34	94,70	
		200	250	3,66	105,30	
		250	300	4,48	140,10	
		300	350	5,29	170,00	
		350	400	6,10	220,90	
400	450	6,92	260,60			
450	500	7,73	276,20			
500	550	8,55	307,80			

Längenelement 360 mm		Technische Daten		Lg*	Preis	2250-Ø-L3
		Ød	ØD	kg	EUR	length 360 mm élément de droit 360 mm modulo lineare L=360 mm schoorsteenelement L=360 mm Труба 360 мм
		80	140	1,19	49,50	
		100	163	1,41	50,80	
		113	163	1,50	51,40	
		130	180	1,68	55,20	
		150	200	1,90	62,00	
		160	213	2,02	68,60	
		180	230	2,22	75,40	
		200	250	2,44	79,30	
		250	300	2,98	104,70	
		300	350	3,53	141,30	
		350	400	4,07	160,60	
400	450	4,61	229,00			
450	500	5,15	243,40			
500	550	5,70	273,30			

Längenelement 1080 mm - kürzbar		Technische Daten		Lg*	Preis	2250-Ø-L10ET
		Ød	ØD	kg	EUR	length 1080 mm cuttable élément droit ajustable 1080 mm modulo lineare 1080 mm accorgibile schoorsteenelement 1080 mm - in te korten Укорачиваемая труба 1080 мм
		80	140	3,58	113,90	
		100	163	4,23	117,40	
		113	163	4,49	119,40	
		130	180	5,05	126,80	
		150	200	5,70	141,30	
		160	213	6,07	151,20	
		180	230	6,67	160,10	
		200	250	7,32	184,80	
		250	300	8,95	246,70	
		300	350	10,58	300,80	
		350	400	12,21	388,30	
400	450	13,84	454,10			
450	500	15,46	466,70			
500	550	17,09	503,40			

*Lg=Legierungsgewicht: Lg (in kg) x Faktor Legierungszuschlag (in €/kg) = Netto-Aufpreis Legierungszuschlag

Längenelement 540 mm - kürzbar		Technische Daten	Lg*	Preis	2250-Ø-L5ET	
		Ø d	Ø D	kg	EUR	<ul style="list-style-type: none"> length 540 mm cuttable élément droit ajustable 540 mm modulo lineare 540 mm accorciabile schoorsteenelement 540 mm , in te korten Укорачиваемая труба 540 мм
		80	140	1,79	67,70	
		100	163	2,12	69,20	
		113	163	2,25	70,10	
		130	180	2,52	73,40	
		150	200	2,85	81,40	
		160	213	3,04	87,90	
		180	230	3,34	94,70	
		200	250	3,66	105,30	
		250	300	4,48	140,10	
		300	350	5,29	170,00	
		350	400	6,10	220,90	
		400	450	6,92	260,60	
450	500	7,73	276,20			
500	550	8,55	307,80			

Längenelement 360 mm - kürzbar		Technische Daten	Lg*	Preis	2250-Ø-L3ET		
		Ø d	Ø D	a	kg	EUR	<ul style="list-style-type: none"> length 360 mm cuttable élément droit ajustable 360 mm modulo lineare 360 mm accorciabile schoorsteenelement 360 mm - in te korten Укорачиваемая труба 360 мм
		80	140		1,19	49,50	
		100	163		1,41	50,80	
		113	163		1,50	51,40	
		130	180		1,68	55,20	
		150	200		1,90	62,00	
		160	213		2,02	68,60	
		180	230		2,22	75,40	
		200	250		2,44	79,30	
		250	300		2,98	104,70	
		300	350		3,53	141,30	
		350	400		4,07	160,60	
		400	450		4,61	229,00	
450	500		5,15	243,40			
500	550		5,70	273,30			

Längenelement mit Meßstutzen		Technische Daten	Lg*	Preis	2250-Ø-LM	
		Ø d	Ø D	kg	EUR	<ul style="list-style-type: none"> length with test point élément droit avec manchon de mesure modulo prelievo fumi schoorsteenelement met meetpunten Труба с штуцером для измерений
		80	140	1,19	97,50	
		100	163	1,41	98,80	
		113	163	1,50	97,30	
		130	180	1,68	103,20	
		150	200	1,90	110,00	
		160	213	2,02	116,70	
		180	230	2,22	123,40	
		200	250	2,44	127,30	
		250	300	2,98	152,70	
		300	350	3,53	189,40	
		350	400	4,07	206,60	
		400	450	4,61	275,10	
450	500	5,15	318,40			
500	550	5,70	341,90			

Längenausgleichselement 330 - 420 mm		Technische Daten	Lg*	Preis	2250-Ø-LA	
		Ø d	Ø D	kg	EUR	<ul style="list-style-type: none"> adjustable length 330 - 420 mm élément adaptable de 330- 420 mm modulo regolabile da 330- 420 mm lengte compensatie element 330 - 420mm Компесационная труба 330 - 420 мм
		80	140	1,58	102,30	
		100	163	1,88	103,40	
		113	163	2,08	104,70	
		130	180	2,34	113,30	
		150	200	2,64	127,30	
		160	213	2,81	140,70	
		180	230	3,09	154,00	
		200	250	3,39	161,30	
		250	300	4,14	212,80	
		300	350	4,90	286,10	
		350	400	5,65	324,50	
		400	450	6,41	461,60	
450	500	7,16	549,20			
500	550	7,91	594,40			

*Lg=Legierungsgewicht: Lg (in kg) x Faktor Legierungszuschlag (in €/kg) = Netto-Aufpreis Legierungszuschlag

Doppelwandiges Schornsteinsystem eka complex D

Isolierdicke 30 mm Ø 80 - 100 mm
Isolierdicke 25 mm ab Ø 113 mm



Längenausgleichselement 420 - 620 mm		Technische Daten		Lg*	Preis	2250-Ø-LA5
		Ød	ØD	kg	EUR	<ul style="list-style-type: none"> adjustable length 420 - 620 mm élément adaptable de 420 - 620 mm modulo regolabile da 420 - 620 mm lengte kompensatie element 420 - 620mm Компенсационная труба 420 - 620 мм
		80	140	2,32	101,60	
		100	163	2,74	104,70	
		113	163	2,91	145,30	
		130	180	3,27	152,70	
		150	200	3,69	169,40	
		160	213	3,94	183,40	
		180	230	4,33	197,50	
		200	250	4,75	220,10	
		250	300	5,80	293,50	
		300	350	6,86	356,10	
		350	400	7,91	463,20	
		400	450	8,97	545,70	
450	500	10,02	579,30			
500	550	11,08	645,70			

Bogen 90°		Technische Daten		Lg*	Preis	2250-Ø-B90					
		Ød	ØD	A	B	a	b	c	kg	EUR	<ul style="list-style-type: none"> elbow 90° coude 90° gomito 90° bocht 90° Отвод 90°
		80	140	267	262	162	157	148	1,56	171,30	
		100	163	278	273	166	161	158	1,61	174,80	
		113	163	278	273	166	161	156	2,00	176,00	
		130	180	287	282	170	165	165	2,31	198,10	
		150	200	297	292	174	169	173	2,69	208,70	
		160	213	303	298	177	172	179	2,93	218,00	
		180	230	312	307	180	175	186	3,30	227,50	
		200	250	322	314	184	179	194	3,73	237,40	
		250	300	347	342	195	190	215	4,89	271,30	
		300	350	372	367	205	200	235	6,17	326,70	
		350	400	397	392	216	211	256	7,57	386,10	
		400	450	422	417	226	221	277	9,10	436,60	
450	500	447	442	237	232	298	10,89	479,50			
500	550	472	467	247	242	318	12,76	533,30			

Bogen 90° mit Prüfföffnung		Technische Daten		Lg*	Preis	2250-Ø-BP90H	2250-Ø-BP90N						
BP90H	max. 600 °C			Ød	ØD	A	B	a	b	c	kg	EUR	<ul style="list-style-type: none"> elbow 90° with inspection door coude 90° avec élément d'inspection gomito 90° con ispezione Bocht 90° met inspectie opening Отвод 90° с окошком для просмотра и очистки
BP90N	max. 200 °C			80	140	267	262	162	157	148	1,56	218,70	
				100	163	278	273	166	161	158	1,90	225,40	
				113	163	278	273	166	161	156	2,00	225,40	
				130	180	287	282	170	165	165	2,31	230,70	
				150	200	297	292	174	169	173	2,69	242,00	
				160	213	303	298	177	172	179	2,93	252,70	
				180	230	312	307	180	175	186	3,30	262,00	
				200	250	322	314	184	179	194	3,73	273,40	
				250	300	347	342	195	190	215	4,89	310,10	
				300	350	372	367	205	200	235	6,17	351,40	
				350	400	397	392	216	211	256	7,57	411,80	
				400	450	422	417	226	221	277	9,10	462,20	
		450	500	447	442	237	232	298	10,89	505,70			
		500	550	472	467	247	242	318	12,76	632,90			

Prüfföffnung nicht in Kondensatfluß einbauen
Aufpreis für Deckel seitlich: LP + 25 %

Bogen 87°		Technische Daten		Lg*	Preis	2250-Ø-B87					
		Ød	ØD	A	B	a	b	c	kg	EUR	<ul style="list-style-type: none"> elbow 87° coude 87° gomito 87° bocht 87° Отвод 87°
		80	140	270	261	161	156	146	1,56	171,30	
		100	163	282	272	165	160	155	1,90	174,80	
		113	163	286	267	165	160	155	2,00	176,00	
		130	180	295	275	169	164	162	2,31	198,10	
		150	200	305	284	173	168	170	2,69	208,70	
		160	213	311	291	175	170	175	2,93	218,00	
		180	230	320	299	179	174	182	3,30	227,50	
		200	250	330	308	183	178	190	3,73	237,40	
		250	300	355	332	193	188	210	4,89	271,30	
		300	350	380	356	203	198	230	6,17	326,70	
		350	400	405	379	212	207	250	7,57	386,10	
		400	450	430	403	222	217	270	9,10	436,60	
450	500	456	431	232	227	290	10,89	479,50			
500	550	479	454	242	237	310	12,76	533,30			

*Lg=Legierungsgewicht: Lg (in kg) x Faktor Legierungszuschlag (in €/kg) = Netto-Aufpreis Legierungszuschlag

Bogen 87° mit Prüfföffnung		Technische Daten	Lg* Preis	2250-Ø-BP87H	2250-Ø-BP87N																																																																																																																																						
BP87H	max. 600 °C		<table border="1"> <thead> <tr> <th>Ø d</th> <th>Ø D</th> <th>A</th> <th>B</th> <th>a</th> <th>b</th> <th>c</th> <th>kg</th> <th>EUR</th> </tr> </thead> <tbody> <tr><td>80</td><td>140</td><td>270</td><td>261</td><td>161</td><td>156</td><td>146</td><td>1,56</td><td>218,70</td></tr> <tr><td>100</td><td>163</td><td>282</td><td>272</td><td>165</td><td>160</td><td>155</td><td>1,90</td><td>225,40</td></tr> <tr><td>113</td><td>163</td><td>286</td><td>267</td><td>165</td><td>160</td><td>155</td><td>2,00</td><td>225,40</td></tr> <tr><td>130</td><td>180</td><td>295</td><td>275</td><td>169</td><td>164</td><td>162</td><td>2,31</td><td>230,70</td></tr> <tr><td>150</td><td>200</td><td>305</td><td>284</td><td>173</td><td>168</td><td>170</td><td>2,69</td><td>242,00</td></tr> <tr><td>160</td><td>213</td><td>311</td><td>291</td><td>175</td><td>170</td><td>175</td><td>2,93</td><td>252,70</td></tr> <tr><td>180</td><td>230</td><td>320</td><td>299</td><td>179</td><td>174</td><td>182</td><td>3,30</td><td>262,00</td></tr> <tr><td>200</td><td>250</td><td>330</td><td>308</td><td>183</td><td>178</td><td>190</td><td>3,73</td><td>273,40</td></tr> <tr><td>250</td><td>300</td><td>355</td><td>332</td><td>193</td><td>188</td><td>210</td><td>4,89</td><td>310,10</td></tr> <tr><td>300</td><td>350</td><td>380</td><td>356</td><td>203</td><td>198</td><td>230</td><td>6,17</td><td>351,40</td></tr> <tr><td>350</td><td>400</td><td>405</td><td>379</td><td>212</td><td>207</td><td>250</td><td>7,57</td><td>411,80</td></tr> <tr><td>400</td><td>450</td><td>430</td><td>403</td><td>222</td><td>217</td><td>270</td><td>9,10</td><td>462,20</td></tr> <tr><td>450</td><td>500</td><td>456</td><td>431</td><td>232</td><td>227</td><td>290</td><td>10,89</td><td>505,70</td></tr> <tr><td>500</td><td>550</td><td>479</td><td>454</td><td>242</td><td>237</td><td>310</td><td>12,76</td><td>632,90</td></tr> </tbody> </table>	Ø d	Ø D	A	B	a	b	c	kg	EUR	80	140	270	261	161	156	146	1,56	218,70	100	163	282	272	165	160	155	1,90	225,40	113	163	286	267	165	160	155	2,00	225,40	130	180	295	275	169	164	162	2,31	230,70	150	200	305	284	173	168	170	2,69	242,00	160	213	311	291	175	170	175	2,93	252,70	180	230	320	299	179	174	182	3,30	262,00	200	250	330	308	183	178	190	3,73	273,40	250	300	355	332	193	188	210	4,89	310,10	300	350	380	356	203	198	230	6,17	351,40	350	400	405	379	212	207	250	7,57	411,80	400	450	430	403	222	217	270	9,10	462,20	450	500	456	431	232	227	290	10,89	505,70	500	550	479	454	242	237	310	12,76	632,90	<ul style="list-style-type: none"> elbow 87° with inspection door coude 87° avec élément d'inspection gomito 87° con ispezione bocht 87° met inspectie opening Отвод 87° с окошком для осмотра и очистки
Ø d	Ø D			A	B	a	b	c	kg	EUR																																																																																																																																	
80	140			270	261	161	156	146	1,56	218,70																																																																																																																																	
100	163			282	272	165	160	155	1,90	225,40																																																																																																																																	
113	163			286	267	165	160	155	2,00	225,40																																																																																																																																	
130	180			295	275	169	164	162	2,31	230,70																																																																																																																																	
150	200			305	284	173	168	170	2,69	242,00																																																																																																																																	
160	213			311	291	175	170	175	2,93	252,70																																																																																																																																	
180	230			320	299	179	174	182	3,30	262,00																																																																																																																																	
200	250			330	308	183	178	190	3,73	273,40																																																																																																																																	
250	300			355	332	193	188	210	4,89	310,10																																																																																																																																	
300	350			380	356	203	198	230	6,17	351,40																																																																																																																																	
350	400			405	379	212	207	250	7,57	411,80																																																																																																																																	
400	450	430	403	222	217	270	9,10	462,20																																																																																																																																			
450	500	456	431	232	227	290	10,89	505,70																																																																																																																																			
500	550	479	454	242	237	310	12,76	632,90																																																																																																																																			
BP87N	max. 200 °C																																																																																																																																										
<p>Prüfföffnung nicht im Kondensatfluß einbauen Aufpreis für Deckel seitlich: LP + 25 %</p>																																																																																																																																											

Bogen 45°		Technische Daten	Lg* Preis	2250-Ø-B45																																																																																									
		<table border="1"> <thead> <tr> <th>Ø d</th> <th>Ø D</th> <th>a</th> <th>b</th> <th>kg</th> <th>EUR</th> </tr> </thead> <tbody> <tr><td>80</td><td>140</td><td>162</td><td>157</td><td>1,03</td><td>92,00</td></tr> <tr><td>100</td><td>163</td><td>166</td><td>161</td><td>1,25</td><td>93,00</td></tr> <tr><td>113</td><td>163</td><td>166</td><td>161</td><td>1,36</td><td>93,20</td></tr> <tr><td>130</td><td>180</td><td>170</td><td>165</td><td>1,56</td><td>96,10</td></tr> <tr><td>150</td><td>200</td><td>174</td><td>169</td><td>1,80</td><td>98,70</td></tr> <tr><td>160</td><td>213</td><td>177</td><td>172</td><td>1,95</td><td>103,20</td></tr> <tr><td>180</td><td>230</td><td>180</td><td>175</td><td>2,20</td><td>109,50</td></tr> <tr><td>200</td><td>250</td><td>184</td><td>179</td><td>2,47</td><td>114,10</td></tr> <tr><td>250</td><td>300</td><td>195</td><td>190</td><td>3,18</td><td>126,80</td></tr> <tr><td>300</td><td>350</td><td>205</td><td>200</td><td>3,96</td><td>173,40</td></tr> <tr><td>350</td><td>400</td><td>216</td><td>211</td><td>4,82</td><td>196,90</td></tr> <tr><td>400</td><td>450</td><td>226</td><td>221</td><td>5,71</td><td>223,60</td></tr> <tr><td>450</td><td>500</td><td>237</td><td>232</td><td>6,70</td><td>235,80</td></tr> <tr><td>500</td><td>550</td><td>247</td><td>242</td><td>7,72</td><td>264,10</td></tr> </tbody> </table>	Ø d	Ø D	a	b	kg	EUR	80	140	162	157	1,03	92,00	100	163	166	161	1,25	93,00	113	163	166	161	1,36	93,20	130	180	170	165	1,56	96,10	150	200	174	169	1,80	98,70	160	213	177	172	1,95	103,20	180	230	180	175	2,20	109,50	200	250	184	179	2,47	114,10	250	300	195	190	3,18	126,80	300	350	205	200	3,96	173,40	350	400	216	211	4,82	196,90	400	450	226	221	5,71	223,60	450	500	237	232	6,70	235,80	500	550	247	242	7,72	264,10	<ul style="list-style-type: none"> elbow 45° coude 45° gomito 45° bocht 45° Отвод 45°
		Ø d	Ø D	a	b	kg	EUR																																																																																						
		80	140	162	157	1,03	92,00																																																																																						
		100	163	166	161	1,25	93,00																																																																																						
		113	163	166	161	1,36	93,20																																																																																						
		130	180	170	165	1,56	96,10																																																																																						
		150	200	174	169	1,80	98,70																																																																																						
		160	213	177	172	1,95	103,20																																																																																						
		180	230	180	175	2,20	109,50																																																																																						
		200	250	184	179	2,47	114,10																																																																																						
		250	300	195	190	3,18	126,80																																																																																						
		300	350	205	200	3,96	173,40																																																																																						
		350	400	216	211	4,82	196,90																																																																																						
400	450	226	221	5,71	223,60																																																																																								
450	500	237	232	6,70	235,80																																																																																								
500	550	247	242	7,72	264,10																																																																																								

Bogen 45° mit Prüfföffnung		Technische Daten	Lg* Preis	2250-Ø-BP45KDISO	2250-Ø-BP45KDVIT																																																																																									
BP45KDISO	max. 600 °C		<table border="1"> <thead> <tr> <th>Ø d</th> <th>Ø D</th> <th>a</th> <th>b</th> <th>kg</th> <th>EUR</th> </tr> </thead> <tbody> <tr><td>80</td><td>140</td><td>162</td><td>222</td><td>1,15</td><td>140,20</td></tr> <tr><td>100</td><td>163</td><td>166</td><td>230</td><td>1,34</td><td>144,60</td></tr> <tr><td>113</td><td>163</td><td>166</td><td>230</td><td>1,63</td><td>144,60</td></tr> <tr><td>130</td><td>180</td><td>170</td><td>270</td><td>2,04</td><td>151,10</td></tr> <tr><td>150</td><td>200</td><td>174</td><td>265</td><td>2,29</td><td>160,50</td></tr> <tr><td>160</td><td>213</td><td>177</td><td>270</td><td>2,63</td><td>171,80</td></tr> <tr><td>180</td><td>230</td><td>180</td><td>330</td><td>3,13</td><td>184,80</td></tr> <tr><td>200</td><td>250</td><td>184</td><td>360</td><td>3,66</td><td>193,30</td></tr> <tr><td>250</td><td>300</td><td>195</td><td>380</td><td>4,73</td><td>231,30</td></tr> <tr><td>300</td><td>350</td><td>205</td><td>370</td><td>4,93</td><td>314,60</td></tr> <tr><td>350</td><td>400</td><td>216</td><td>220</td><td>5,17</td><td>372,80</td></tr> <tr><td>400</td><td>450</td><td>226</td><td>220</td><td>5,58</td><td>403,20</td></tr> <tr><td>450</td><td>500</td><td>237</td><td>230</td><td>6,69</td><td>433,80</td></tr> <tr><td>500</td><td>550</td><td>247</td><td>310</td><td>8,82</td><td>495,80</td></tr> </tbody> </table>	Ø d	Ø D	a	b	kg	EUR	80	140	162	222	1,15	140,20	100	163	166	230	1,34	144,60	113	163	166	230	1,63	144,60	130	180	170	270	2,04	151,10	150	200	174	265	2,29	160,50	160	213	177	270	2,63	171,80	180	230	180	330	3,13	184,80	200	250	184	360	3,66	193,30	250	300	195	380	4,73	231,30	300	350	205	370	4,93	314,60	350	400	216	220	5,17	372,80	400	450	226	220	5,58	403,20	450	500	237	230	6,69	433,80	500	550	247	310	8,82	495,80	<ul style="list-style-type: none"> elbow 45° with inspection-door Coude avec trappe de visite Curva 45° con ispezione bocht 45° met inspectie opening Отвод 45 с окошком
Ø d	Ø D			a	b	kg	EUR																																																																																							
80	140			162	222	1,15	140,20																																																																																							
100	163			166	230	1,34	144,60																																																																																							
113	163			166	230	1,63	144,60																																																																																							
130	180			170	270	2,04	151,10																																																																																							
150	200			174	265	2,29	160,50																																																																																							
160	213			177	270	2,63	171,80																																																																																							
180	230			180	330	3,13	184,80																																																																																							
200	250			184	360	3,66	193,30																																																																																							
250	300			195	380	4,73	231,30																																																																																							
300	350			205	370	4,93	314,60																																																																																							
350	400			216	220	5,17	372,80																																																																																							
400	450	226	220	5,58	403,20																																																																																									
450	500	237	230	6,69	433,80																																																																																									
500	550	247	310	8,82	495,80																																																																																									
BP45KDVIT	max. 200 °C																																																																																													
<p>Prüfföffnung nicht im Kondensatfluß einbauen</p>																																																																																														

Bogen 30°		Technische Daten	Lg* Preis	2250-Ø-B30																																																																																									
		<table border="1"> <thead> <tr> <th>Ø d</th> <th>Ø D</th> <th>a</th> <th>b</th> <th>kg</th> <th>EUR</th> </tr> </thead> <tbody> <tr><td>80</td><td>140</td><td>151</td><td>146</td><td>0,98</td><td>92,00</td></tr> <tr><td>100</td><td>163</td><td>154</td><td>149</td><td>1,19</td><td>93,00</td></tr> <tr><td>113</td><td>163</td><td>154</td><td>149</td><td>1,26</td><td>93,20</td></tr> <tr><td>130</td><td>180</td><td>157</td><td>152</td><td>1,44</td><td>96,10</td></tr> <tr><td>150</td><td>200</td><td>159</td><td>154</td><td>1,66</td><td>98,70</td></tr> <tr><td>160</td><td>213</td><td>161</td><td>156</td><td>1,78</td><td>103,20</td></tr> <tr><td>180</td><td>230</td><td>163</td><td>158</td><td>1,99</td><td>109,50</td></tr> <tr><td>200</td><td>250</td><td>166</td><td>161</td><td>2,21</td><td>114,10</td></tr> <tr><td>250</td><td>300</td><td>173</td><td>168</td><td>2,82</td><td>126,80</td></tr> <tr><td>300</td><td>350</td><td>179</td><td>174</td><td>3,47</td><td>173,40</td></tr> <tr><td>350</td><td>400</td><td>186</td><td>181</td><td>4,14</td><td>196,90</td></tr> <tr><td>400</td><td>450</td><td>193</td><td>188</td><td>4,87</td><td>223,60</td></tr> <tr><td>450</td><td>500</td><td>200</td><td>195</td><td>5,64</td><td>235,80</td></tr> <tr><td>500</td><td>550</td><td>207</td><td>202</td><td>6,46</td><td>264,10</td></tr> </tbody> </table>	Ø d	Ø D	a	b	kg	EUR	80	140	151	146	0,98	92,00	100	163	154	149	1,19	93,00	113	163	154	149	1,26	93,20	130	180	157	152	1,44	96,10	150	200	159	154	1,66	98,70	160	213	161	156	1,78	103,20	180	230	163	158	1,99	109,50	200	250	166	161	2,21	114,10	250	300	173	168	2,82	126,80	300	350	179	174	3,47	173,40	350	400	186	181	4,14	196,90	400	450	193	188	4,87	223,60	450	500	200	195	5,64	235,80	500	550	207	202	6,46	264,10	<ul style="list-style-type: none"> elbow 30° coude 30° gomito 30° bocht 30° Отвод 30°
		Ø d	Ø D	a	b	kg	EUR																																																																																						
		80	140	151	146	0,98	92,00																																																																																						
		100	163	154	149	1,19	93,00																																																																																						
		113	163	154	149	1,26	93,20																																																																																						
		130	180	157	152	1,44	96,10																																																																																						
		150	200	159	154	1,66	98,70																																																																																						
		160	213	161	156	1,78	103,20																																																																																						
		180	230	163	158	1,99	109,50																																																																																						
		200	250	166	161	2,21	114,10																																																																																						
		250	300	173	168	2,82	126,80																																																																																						
		300	350	179	174	3,47	173,40																																																																																						
		350	400	186	181	4,14	196,90																																																																																						
400	450	193	188	4,87	223,60																																																																																								
450	500	200	195	5,64	235,80																																																																																								
500	550	207	202	6,46	264,10																																																																																								

*Lg=Legierungsgewicht: Lg (in kg) x Faktor Legierungszuschlag (in €/kg) = Netto-Aufpreis Legierungszuschlag

Doppelwandiges Schornsteinsystem eka complex D

Isolierdicke 30 mm Ø 80 - 100 mm
Isolierdicke 25 mm ab Ø 113 mm



Bogen 15°		Technische Daten				Lg*	Preis	2250-Ø-B15	
		Ø d	Ø D	a	b	kg	EUR	elbow 15° coude 15° gomito 15° con bocht 15° Отвод 15°	
		80	140	142	137	0,93	92,00		
		100	163	143	138	1,11	93,00		
		113	163	143	138	1,17	93,20		
		130	180	144	139	1,33	96,10		
		150	200	146	141	1,51	98,70		
		160	213	147	142	1,62	103,20		
		180	230	148	143	1,79	109,50		
		200	250	149	144	1,98	114,10		
		250	300	152	147	2,49	126,80		
		300	350	156	151	3,00	173,40		
		350	400	159	154	3,53	196,90		
		400	450	162	157	4,10	223,60		
450	500	165	160	4,67	235,80				
500	550	168	163	5,25	264,10				

Klemmband		Technische Daten				Lg*	Preis	2250-Ø-KDW	
		Ø d	Ø D			kg	EUR	locking band colliers de fixation fascia chiusura giunzioni klemband Крепёжный хомут	
		80	140			-	19,10		
		100	163			-	19,50		
		113	163			-	19,50		
		130	180			-	20,10		
		150	200			-	20,80		
		160	213			-	20,80		
		180	230			-	21,60		
		200	250			-	22,10		
		250	300			-	23,60		
		300	350			-	26,20		
		350	400			-	26,30		
		400	450			-	27,00		
450	500			-	27,60				
500	550			-	28,20				

Dachdurchführung flach Edelstahl		Technische Daten				Lg*	Preis	2250-Ø-DF	
<p>0 - 10°</p>	<p>Grundplatte auch aus Blei erhältlich</p>	Ø d	Ø a	b	kg	EUR	flat flashing solin de toit plat faldale piatto con scossalina Dakdoorvoer vlak roestvaststaal Элемент для прохода через крышу горизонтальный из нержав. стали		
		80	193	628	-	47,50			
		100	193	628	-	47,50			
		113	193	628	-	47,50			
		130	240	690	-	50,90			
		150	240	690	-	50,90			
		160	240	690	-	50,90			
		180	290	740	-	57,50			
		200	290	740	-	57,50			
		250	340	780	-	76,20			
		300	390	820	-	94,30			
		350	430	880	-	112,20			
		400	480	930	-	120,40			
450	530	980	-	189,50					
500	580	1030	-	199,50					

Dachdurchführung flach Edelstahl, zylindrisch, 400 mm hoch DFZ		Technische Daten				Lg*	Preis	2250-Ø-DFZ	
<p>nur 0°</p>	<p>Grundplatte auch aus Blei erhältlich</p>	Ø d	Ø a	bx b	kg	EUR	flat flashing 400 mm solin de toit plat 400 mm faldale piatto con scossalina 400 mm Dakdoorvoer vlak roestvaststaal 400 mm Элемент для прохода через крышу горизонтальный из нержав. стали 400 mm		
		80	210	610		78,10			
		100	210	610		78,10			
		113	210	610		78,10			
		130	260	660		83,90			
		150	260	660		83,90			
		160	260	660		83,90			
		180	310	710		93,70			
		200	310	710		93,70			
		250	360	760		121,60			
		300	410	810		147,60			
		350	450	850		172,80			
		400	500	900		185,60			
450	550	950		261,80					
500	600	1000		278,90					

*Lg=Legierungsgewicht: Lg (in kg) x Faktor Legierungszuschlag (in €/kg) = Netto-Aufpreis Legierungszuschlag

Dachdurchführung geneigt 22° mit Blei		Technische Daten	Lg*	Preis	2250-Ø-DGB22			
<p>Aufpreis für zylindrische Ausführung. Genauere Gradzahl angeben.</p>	<p>Grundplatte auch aus Edelstahl erhältlich</p>	Ø d	Ø a	b	c	kg	EUR	adjustable flashing 22° solin de toit incliné 22° en plomb façonnable faldale inclinato 22° con biombo Dakdoorvoer 22° met lood Элемент для прохода через крышу наклонный 22° из свинца
		80	193	800	730	-	128,90	
		100	193	800	730	-	128,90	
		113	193	800	730	-	128,90	
		130	243	800	730	-	140,20	
		150	243	800	730	-	140,20	
		160	243	800	730	-	140,20	
		180	290	900	820	-	152,80	
		200	290	900	820	-	152,80	
		250	340	900	820	-	171,00	
		300	390	1000	880	-	184,30	
		350	430	1010	930	-	206,80	
		400	480	1070	990	-	211,10	
450	530	1120	1040	-	224,60			
500	580	1180	1100	-	232,20			

Dachdurchführung geneigt 32° mit Blei		Technische Daten	Lg*	Preis	2250-Ø-DGB32			
<p>Aufpreis für zylindrische Ausführung. Genauere Gradzahl angeben.</p>	<p>Grundplatte auch aus Edelstahl erhältlich</p>	Ø d	Ø a	b	c	kg	EUR	adjustable flashing 32° solin de toit incliné 32° en plomb façonnable faldale inclinato 32° con biombo Dakdoorvoer 32° met lood Элемент для прохода через крышу наклонный 32° из свинца
		80	193	800	730	-	128,90	
		100	193	800	730	-	128,90	
		113	193	800	730	-	128,90	
		130	243	900	820	-	140,20	
		150	243	900	820	-	140,20	
		160	243	900	820	-	140,20	
		180	290	1000	880	-	152,80	
		200	290	1000	880	-	152,80	
		250	340	1000	880	-	171,00	
		300	390	1140	900	-	184,30	
		350	430	1140	900	-	206,80	
		400	480	1200	930	-	211,10	
450	530	1200	930	-	224,60			
500	580	1300	1100	-	232,20			

Dachdurchführung geneigt 45° mit Blei		Technische Daten	Lg*	Preis	2250-Ø-DGB45			
<p>Aufpreis für zylindrische Ausführung. Genauere Gradzahl angeben.</p>	<p>Grundplatte auch aus Edelstahl erhältlich</p>	Ø d	Ø a	b	c	kg	EUR	adjustable flashing 45° solin de toit incliné 45° en plomb façonnable faldale inclinato 45° con biombo Dakdoorvoer 45° met lood Элемент для прохода через крышу наклонный 45° из свинца
		80	193	900	820	-	155,50	
		100	193	900	820	-	155,50	
		113	193	900	820	-	155,50	
		130	243	1000	880	-	168,90	
		150	243	1000	880	-	168,90	
		160	243	1000	880	-	168,90	
		180	290	1140	900	-	192,90	
		200	290	1140	900	-	192,90	
		250	340	1140	900	-	222,90	
		300	390	1200	930	-	236,20	
		350	430	1270	990	-	267,60	
		400	480	1340	1050	-	288,60	
450	530	1400	1110	-	301,30			
500	580	1480	1170	-	316,60			

Regenkragen		Technische Daten	Lg*	Preis	2250-Ø-RK		
		Ø d	Ø D	Ø a	kg	EUR	rain / storm collar collerette collare anti-pioggia regenrand Дождевой козырёк
		80	140	296	-	20,80	
		100	163	316	-	20,80	
		113	163	316	-	20,80	
		130	180	336	-	22,10	
		150	200	356	-	23,60	
		160	213	369	-	23,60	
		180	230	386	-	24,80	
		200	250	406	-	26,20	
		250	300	456	-	30,90	
		300	350	506	-	32,10	
		350	400	556	-	40,90	
		400	450	605	-	55,10	
450	500	656	-	62,10			
500	550	706	-	69,80			

*Lg=Legierungsgewicht: Lg (in kg) x Faktor Legierungszuschlag (in €/kg) = Netto-Aufpreis Legierungszuschlag

Doppelwandiges Schornsteinsystem eka complex D

Isolierdicke 30 mm Ø 80 - 100 mm
Isolierdicke 25 mm ab Ø 113 mm



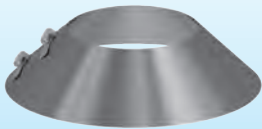
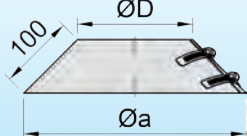

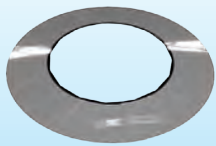
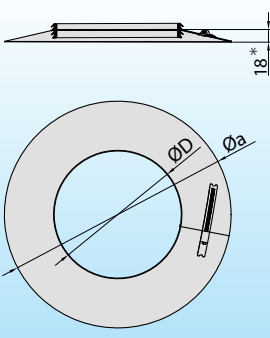
Regenkragen 45°		Technische Daten		Lg*	Preis	2250-Ø-RK45	
		Ø d	Ø D	Ø a	kg	EUR	Storm collar, 45° colerette pare-pluie, 45° collare anti pioggia 45° regenkraag 45° Дождевой козырек 45°
		80	140	281	-	31,20	
		100	163	304	-	31,20	
		113	163	304	-	31,20	
		130	180	321	-	33,20	
		150	200	341	-	35,40	
		160	213	354	-	35,40	
		180	230	371	-	37,10	
		200	250	391	-	39,30	
		250	300	441	-	46,30	
		300	350	491	-	48,10	

Regenkragen mit Dichtung		Technische Daten		Preis		2250-Ø-RKED 2250-Ø-RKED45		
		Ø d	Ø D	Ø a	Ø a	EUR	EUR	Storm collar, with sealant, colerette pare-pluie, avec joint, collare anti pioggia con guarnizione regenkraag Дождевой козырек с уплотнительным кольцом
		80	140	296	286	28,40	38,80	
		100	163	316	309	29,50	39,80	
		113	163	316	309	29,50	39,80	
		130	180	336	326	32,10	43,20	
		150	200	356	346	34,40	46,20	
		160	213	369	359	34,40	46,20	
		180	230	386	376	38,10	49,00	
		200	250	406	396	39,50	52,60	
		250	300	456	446	46,60	62,00	
		300	350	506	496	50,60	66,60	

Typ RKED45
Regenkragen 45°

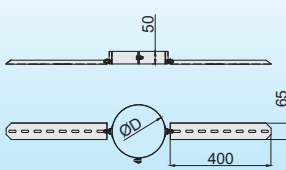
* bei RKED45 = 56 mm

Sparrenbefestigung		Technische Daten		Lg*	Preis	2250-Ø-S	
		Ø d	Ø D		kg	EUR	roof bracket fixation aux chevrons collare di fissaggio daksparbefestiging Стропильное крепление
		80	140		-	37,60	
		100	163		-	37,60	
		113	163		-	37,60	
		130	180		-	38,90	
		150	200		-	39,40	
		160	213		-	39,40	
		180	230		-	40,20	
		200	250		-	40,90	
		250	300		-	42,90	
		300	350		-	50,90	
350	400		-	58,90			
400	450		-	75,60			
450	500		-	84,60			
500	550		-	92,20			

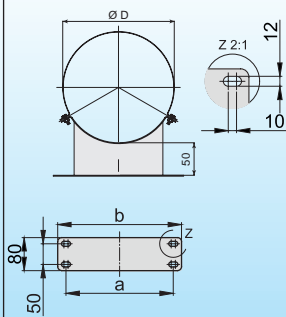
Wandhalter (Wandabstand 50 mm)		Technische Daten		Lg*	Preis	2250-Ø-W		
		Ø d	Ø D	a	b	kg	EUR	wall band, distance 50 mm bride de fixation murale, distance 50 mm collare di fissaggio a parete, distanza 50 mm Wandhouder 50 mm Настенный кронштейн 50 мм
		80	140	150	190	-	48,50	
		100	163	163	210	-	49,40	
		113	163	163	210	-	49,40	
		130	180	180	220	-	51,30	
		150	200	200	240	-	52,40	
		160	213	213	250	-	52,40	
		180	230	230	270	-	53,60	
		200	250	250	290	-	57,10	
		250	300	300	340	-	63,10	
		300	350	350	390	-	72,20	
350	400	400	440	-	91,50			
400	450	450	490	-	97,90			
450	500	500	540	-	111,10			
500	550	550	590	-	126,70			

*Lg=Legierungsgewicht: Lg (in kg) x Faktor Legierungszuschlag (in €/kg) = Netto-Aufpreis Legierungszuschlag

Wandhalter (Wandabstand 75 mm)		Technische Daten	Lg*	Preis	2250-Ø-W75				
		Ø d	Ø D	a	b	kg	EUR	<ul style="list-style-type: none"> wall band, distance 75 mm bride de fixation murale, distance 75 mm collare di fissaggio a parete, distanza 75 mm Wandhouder 75 mm Настенный кронштейн 75 мм 	
		80	140	150	190	-	-		51,10
		100	163	163	210	-	-		52,00
		113	163	163	210	-	-		52,00
		130	180	180	220	-	-		54,00
		150	200	200	240	-	-		55,00
		160	213	213	250	-	-		55,00
		180	230	230	270	-	-		56,40
		200	250	250	290	-	-		60,00
		250	300	300	340	-	-		66,40
		300	350	350	390	-	-		75,90
		350	400	400	440	-	-		92,10
		400	450	450	490	-	-		102,80
450	500	500	540	-	-	116,70			
500	550	550	590	-	-	133,10			

Wandhalter verstellbar 50 - 90 mm		Technische Daten	Lg*	Preis	2250-Ø-WHV				
		Ø d	Ø D	a	b	kg	EUR	<ul style="list-style-type: none"> adjustable wall band 50-90 mm bride de fixation, réglable murale 50-90 mm supporto a muro regolabile 50-90 mm Wandhouder, verstellbaar 50-90 mm Настенный кронштейн, регулируемый 50-90 мм 	
		80	140	150	190	-	-		59,90
		100	163	163	210	-	-		62,20
		113	163	163	210	-	-		62,20
		130	180	180	220	-	-		66,90
		150	200	200	240	-	-		72,20
		160	213	213	250	-	-		72,20
		180	230	230	270	-	-		78,10
		200	250	250	290	-	-		84,20
		250	300	300	340	-	-		99,50
		300	350	350	390	-	-		102,90
		350	400	400	440	-	-		111,50
		400	450	450	490	-	-		119,70
450	500	500	540	-	-	142,10			
500	550	550	590	-	-	158,10			

Wandhalter verstellbar 90 - 160 mm		Technische Daten	Lg*	Preis	2250-Ø-WHV9				
		Ø d	Ø D	a	b	kg	EUR	<ul style="list-style-type: none"> adjustable wall band 90-160 mm bride de fixation, réglable murale 90-160 mm supporto a muro regolabile 90-160 mm Wandhouder, verstellbaar 90-160 mm Настенный кронштейн, регулируемый 90-160 мм 	
		80	140	150	190	-	-		73,70
		100	163	163	210	-	-		74,80
		113	163	163	210	-	-		74,80
		130	180	180	220	-	-		75,50
		150	200	200	240	-	-		78,90
		160	213	213	250	-	-		78,90
		180	230	230	270	-	-		84,80
		200	250	250	290	-	-		91,60
		250	300	300	340	-	-		108,20
		300	350	350	390	-	-		112,90
		350	400	400	440	-	-		122,90
		400	450	450	490	-	-		131,80
450	500	500	540	-	-	156,00			
500	550	550	590	-	-	173,50			

Wandhalter verstellbar 160 - 250 mm		Technische Daten	Lg*	Preis	2250-Ø-WHV16				
		Ø d	Ø D	a	b	kg	EUR	<ul style="list-style-type: none"> adjustable wall band 160-250 mm bride de fixation, réglable murale 160-250 mm supporto a muro regolabile 160-250 mm Wandhouder, verstellbaar 160-250 mm Настенный кронштейн, регулируемый 160-250 мм 	
		80	140	150	190	-	-		84,60
		100	163	163	210	-	-		85,50
		113	163	163	210	-	-		85,50
		130	180	180	220	-	-		86,20
		150	200	200	240	-	-		88,90
		160	213	213	250	-	-		88,90
		180	230	230	270	-	-		96,30
		200	250	250	290	-	-		103,40
		250	300	300	340	-	-		122,90
		300	350	350	390	-	-		130,10
		350	400	400	440	-	-		142,30
		400	450	450	490	-	-		153,00
450	500	500	540	-	-	172,70			
500	550	550	590	-	-	201,10			

*Lg=Legierungsgewicht: Lg (in kg) x Faktor Legierungszuschlag (in €/kg) = Netto-Aufpreis Legierungszuschlag

Doppelwandiges Schornsteinsystem eka complex D

Isolierdicke 30 mm Ø 80 - 100 mm
Isolierdicke 25 mm ab Ø 113 mm



Wandhalter verstellbar 250 - 400 mm		Technische Daten		Lg*	Preis	2250-Ø-WHV25			
		Ø d	Ø D	a	b	kg	EUR	<ul style="list-style-type: none"> adjustable wall band 250 - 400 mm bride de fixation, réglable murale 250 - 400 mm supporto a muro regolabile 250 - 400 mm Wandhouder, verstelbaar 250 - 400 mm Настенный кронштейн, регулируемый 250- 400 мм 	
		80	140	150	190	-	-		112,70
		100	163	163	210	-	-		114,90
		113	163	163	210	-	-		114,90
		130	180	180	220	-	-		116,80
		150	200	200	240	-	-		120,90
		160	213	213	250	-	-		120,90
		180	230	230	270	-	-		130,10
		200	250	250	290	-	-		139,60
		250	300	300	340	-	-		163,60
		300	350	350	390	-	-		175,50
		350	400	400	440	-	-		192,40
400	450	450	490	-	-	205,40			
450	500	500	540	-	-	229,70			
500	550	550	590	-	-	262,20			

Wandhalterverlängerung, verstellbar 100-250 mm		Technische Daten		Lg*	Preis	2250-Ø-WVLK					
		Ø d	A	B	C	G	H	kg	EUR	<ul style="list-style-type: none"> adjustable extension for wall band 100 -250 mm rallonge de fixation murale, réglable 100 -250 mm supporto a muro regolabile 100 -250 mm Wandhouder verlenging verstelbaar 100 - 250mm Удлиняющий элемент настенного кронштейна раздвижной 100 - 250 мм 	
		80	160	200	263	430	480	-	-		88,70
		100	190	225	290	430	480	-	-		92,00
		113	190	225	290	430	480	-	-		92,00
		130	190	225	290	430	480	-	-		92,00
		150	190	225	290	430	480	-	-		92,00
		160	230	275	340	480	530	-	-		94,60
		180	230	275	340	480	530	-	-		94,60
		200	230	275	340	480	530	-	-		94,60
		250	280	325	390	480	530	-	-		98,30
		300	350	375	440	530	580	-	-		105,90
		350	400	425	490	580	630	-	-		121,30
400	450	475	540	630	680	-	-	123,50			
450	500	525	590	680	730	-	-	130,80			
500	550	575	640	730	780	-	-	134,40			

Wandhalterverlängerung, verstellbar 100-500 mm		Technische Daten		Lg*	Preis	2250-Ø-WVLL					
		Ø d	A	B	C	G	H	kg	EUR	<ul style="list-style-type: none"> adjustable extension for wall band 100 -500 mm rallonge de fixation murale, réglable 100 -500 mm supporto a muro regolabile 100 -500 mm Wandhouder verlenging verstelbaar 100 - 500 mm Удлиняющий элемент настенного кронштейна раздвижной 100 - 500 мм 	
		80	160	200	263	430	480	-	-		101,60
		100	190	225	290	430	480	-	-		104,30
		113	190	225	290	430	480	-	-		104,30
		130	190	225	290	430	480	-	-		104,30
		150	190	225	290	430	480	-	-		104,30
		160	230	275	340	480	530	-	-		107,60
		180	230	275	340	480	530	-	-		107,60
		200	230	275	340	480	530	-	-		107,60
		250	280	325	390	480	530	-	-		111,50
		300	350	375	440	530	580	-	-		119,60
		350	400	425	490	580	630	-	-		127,50
400	450	475	540	630	680	-	-	129,90			
450	500	525	590	680	730	-	-	137,50			
500	550	575	640	730	780	-	-	145,30			

Einzeldichtung, max. 200°C		Technische Daten		Lg*	Preis	1000-Ø-ED
		Ø d		kg	EUR	<ul style="list-style-type: none"> Gasket, max. 200°C, natural gas joint pour manchon, à triple lèvre, max. 200°C, gas naturel guarnizione, max. 200°C, naturel di gas siliconen afdichtingsring max. 200°C Уплотнительное кольцо
		80		-	5,40	
		100		-	6,60	
		113		-	7,00	
		130		-	7,90	
		150		-	9,10	
		160		-	9,20	
		180		-	10,60	
		200		-	11,50	
		250		-	14,10	
		300		-	16,70	
		350		-	19,70	
400		-	22,60			
450		-	26,30			
500		-	29,70			

für Erdgas-Anlagen max. 200°C

*Lg=Legierungsgewicht: Lg (in kg) x Faktor Legierungszuschlag (in €/kg) = Netto-Aufpreis Legierungszuschlag

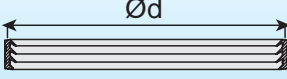
Einzeldichtung Viton, max. 200°C		Technische Daten		Lg*	Preis	1000-Ø-EDVIT
 für Öl-Brennwert-Anlagen max. 200°C, BHKW-Anlagen		Ø d	kg		EUR	Viton Gasket, max. 200°C
		80	-		22,30	joint pour manchon, à triple lèvre, max. 200°C
		100	-		26,00	guarnizione, max. 200°C
		113	-		29,00	viton afdichtingsring max. 200°C
		130	-		32,20	Уплотнительное кольцо ВИТОН
		150	-		35,50	
		160	-		37,30	
		180	-		41,60	
		200	-		44,90	
		250	-		54,40	
		300	-		63,80	
		350	-		79,80	
		400	-		91,80	
450	-		103,30			
500	-		115,50			

Gleitmittel		Technische Daten		Lg*	Preis	1000-000-GM
 für ED und EDVIT verwenden		ml			EUR	silicon grease
		100			4,60	agent lubrifiant pour montage
						grasso
						glijmiddel
						Монтажная смазка

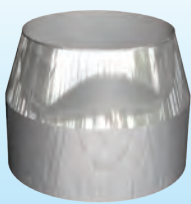
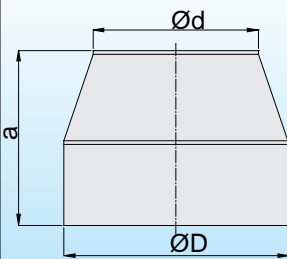
Mündungsabschluss		Technische Daten			Lg*	Preis	2250-Ø-M
 	Ø d	Ø D	a	kg	EUR	Top stub	
	80	140	190	0,83	39,40	finition conique	
	100	163	190	0,91	39,40	terminale troncocono	
	113	163	190	0,97	39,40	Ingangsafsluiting conisch	
	130	180	190	1,07	43,50	Завершающий элемент, конический	
	150	200	190	1,18	52,20		
	160	213	190	1,24	52,80		
	180	230	190	1,36	53,50		
	200	250	190	1,48	54,80		
	250	300	190	1,77	69,60		
	300	350	190	2,06	86,90		
	350	400	190	2,36	106,70		
	400	450	190	2,65	128,40		
450	500	190	2,95	154,20			
500	550	190	3,24	184,90			

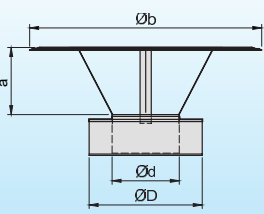
Regenhaube mit Mündungsabschluss		Technische Daten			Lg*	Preis	2250-Ø-RH	
 Ausführung mit Vogelschutzgitter / Funkenfluggitter: bis DN250: LP + 30 € / DN300 – DN500: LP + 60 €		Ø d	Ø D	a	b	kg	EUR	Rain cap
		80	140	80	240	0,77	68,10	chapeau pare-pluie sur cape de dilatation
		100	163	100	360	0,89	68,10	cappello cinese
		113	163	113	360	0,97	68,10	Regenkap met ingangsafsluiting
		130	180	130	360	1,07	76,20	Дождевой козырек с завершающим элементом
		150	200	150	360	1,18	92,20	
		160	213	160	360	1,24	96,30	
		180	230	180	450	1,36	100,10	
		200	250	200	450	1,48	108,80	
		250	300	250	450	1,77	144,30	
		300	350	250	500	2,06	185,00	
		350	400	250	550	2,36	232,60	
		400	450	250	600	2,65	271,90	
450	500	250	650	2,95	310,90			
500	550	250	700	3,24	340,80			

*Lg=Legierungsgewicht: Lg (in kg) x Faktor Legierungszuschlag (in €/kg) = Netto-Aufpreis Legierungszuschlag

Doppelwandiges Schornsteinsystem eka complex D

Isolierdicke 30 mm Ø 80 - 100 mm
Isolierdicke 25 mm ab Ø 113 mm

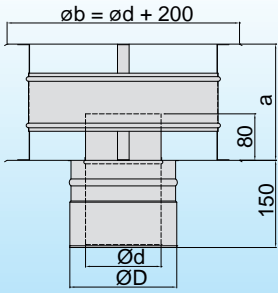

Regenhaube mit Windabweiser		Technische Daten		Lg*	Preis	2250-Ø-RHWI	
 <p>Ausführung mit Klappdeckel: Aufpreis 40 €</p>		Ø d	Ø D	a	kg	EUR	<ul style="list-style-type: none"> Rain cap chapeau pare-pluie sur cape de dilatation cappello cinese Regenkap met ingangsfsluiting Дождевой козырек с завершающим элементом
		80	140	200	0,77	112,30	
		100	163	200	0,89	112,30	
		113	163	200	0,97	112,30	
		130	180	200	1,07	120,00	
		150	200	200	1,18	139,70	
		160	213	200	1,24	150,60	
		180	230	200	1,36	161,30	
		200	250	200	1,48	184,40	
		250	300	200	1,77	226,10	
		300	350	200	2,06	318,00	

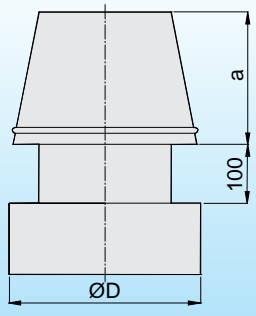
Abströmkopf		Technische Daten		Lg*	Preis	2250-Ø-AK	
		Ø d	Ø D	a	kg	EUR	<ul style="list-style-type: none"> injector top stub chapeau d'accélération cappello toncocono uitmondingskap Оголовок с коническим завершающим элементом
		80	140	180	0,97	162,20	
		100	163	180	0,97	162,20	
		113	163	180	0,97	162,20	
		130	180	200	1,07	171,00	
		150	200	210	1,18	180,30	
		160	213	250	1,24	188,20	
		180	230	260	1,36	196,20	
		200	250	290	1,48	211,60	
		250	300	320	1,77	269,60	
		300	350	340	2,06	306,20	
350	400	370	2,36	345,50			
400	450	410	2,65	412,00			
450	500	470	2,95	416,20			
500	550	520	3,24	448,50			

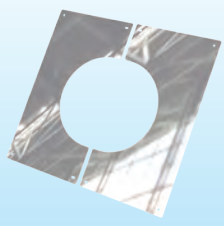
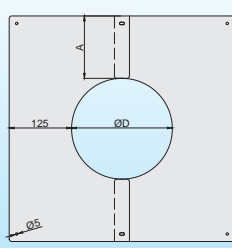
Zweiteilige Blende 0°/45°/60°		Technische Daten			2250-Ø-BL 2250-Ø-BL-RU	
		Ø	BL 0° Blende 2-teilig 0° 125 mm umlaufend	BL 45° Blende 2-teilig 45° 125 mm umlaufend	BL 60° Blende 2-teilig 60° 125 mm umlaufend	
<p>Typ BL-RU Blende rund umlaufend 125 mm</p>  <p>Sondergrößen: Preis auf Anfrage. Maß A: min. 125mm an Dachneigung angepasst.</p>	 <p>Gradzahl entsprechend Dachneigung angeben</p>	80	40,40	53,80	59,80	<ul style="list-style-type: none"> face plate plaque pare-feu, demi-ronde, prière de préciser la pente en degrés de votre toiture rivestimento diviso in due avvolgente 0° fino 45° fino 60° tweedelige afschermplaat omlopend, 0°-45°-60° Защитный лист для прохода через стену под углом
		100	40,40	53,80	59,80	
		113	40,40	53,80	59,80	
		130	40,40	53,80	59,80	
		150	40,40	53,80	59,80	
		160	40,40	53,80	59,80	
		180	40,40	53,80	59,80	
		200	40,40	53,80	59,80	
		250	40,40	53,80	59,80	
		300	46,80	61,80	70,10	
		350	54,40	73,70	82,20	
400	60,50	82,30	92,10			
450	69,70	95,40	106,90			
500	75,80	104,20	116,70			

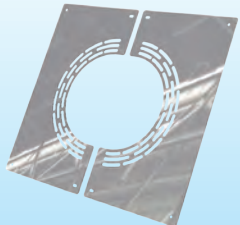
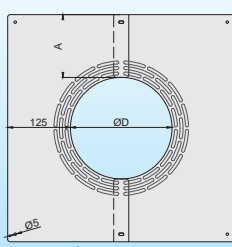
Zweiteilige Blende , 0°/45°/60° (mit Hinterlüftung)		Technische Daten			2250-Ø-BLH 2250-Ø-BLH-RU	
		Ø	BLH 0° Blende 2-teilig 0° mit Hinterlüftung 125 mm umlaufend	BLH 45° Blende 2-teilig 45° mit Hinterlüftung 125 mm umlaufend	BLH 60° Blende 2-teilig 60° mit Hinterlüftung 125 mm umlaufend	
<p>Typ BLH-RU Blende rund umlaufend 125 mm</p>  <p>Sondergrößen: Preis auf Anfrage. Maß A: min. 125mm an Dachneigung angepasst.</p>	 <p>Gradzahl entsprechend Dachneigung angeben</p>	80	56,40	76,50	85,50	<ul style="list-style-type: none"> face plate with ventilation plaque pare-feu, demi-ronde, prière de préciser la pente en degrés de votre toiture Rivestimento diviso in due retroventilato avvolgente 0° fino 45° fino 60° tweedelige afschermplaat belucht omlopend, 0°-45°-60° Защитный лист для прохода через стену с подачей воздуха
		100	56,40	76,50	85,50	
		113	56,40	76,50	85,50	
		130	56,40	76,50	85,50	
		150	56,40	76,50	85,50	
		160	56,40	76,50	85,50	
		180	56,40	76,50	85,50	
		200	56,40	76,50	85,50	
		250	56,40	76,50	85,50	
		300	66,00	90,20	100,80	
		350	77,50	106,40	119,20	
400	86,60	119,40	134,00			
450	100,40	139,10	156,10			
500	109,70	152,20	170,90			

*Lg=Legierungsgewicht: Lg (in kg) x Faktor Legierungszuschlag (in €/kg) = Netto-Aufpreis Legierungszuschlag

Zweiteilige Blende 0° – 15° / 15° – 30° / 30° – 45°		Ø	BL 0 – 15 Blende 2-teilig 0-15° 125 mm umlaufend	BL 15 – 30 Blende 2-teilig 15-30° 125 mm umlaufend	BL 30 – 45 Blende 2-teilig 30-45° 125 mm umlaufend	2250-Ø-BLxx-XX
		80	42,40	44,50	46,80	face plate plaque pare-feu, demi-ronde, prière de préciser la pente en degrés de votre toiture rivestimento diviso in due avvolgente 0°-15° / 15°-30° / 30° - 45° tweedelige afschermplaat omlopend, 0°-15° / 15°-30° / 30° - 45° Защитный лист для прохода через стену под углом
		100	42,40	44,50	46,80	
		113	42,40	44,50	46,80	
		130	42,40	44,50	46,80	
		150	42,40	44,50	46,80	
		160	42,40	44,50	46,80	
		180	42,40	44,50	46,80	
		200	42,40	44,50	46,80	
		250	42,40	44,50	46,80	
		300	49,10	51,60	54,20	
		350	57,10	60,00	63,00	
		400	63,50	66,70	70,00	
450	73,20	76,80	80,70			
500	79,60	83,60	87,70			

Zweiteilige Blende 0° – 15° / 15° – 30° / 30° – 45° (mit Hinterlüftung)		Ø	BLH 0 – 15 Blende 2-teilig 0-15° mit Hinterlüftung 125 mm umlaufend	BLH 15 – 30 Blende 2-teilig 15-20° mit Hinterlüftung 125 mm umlaufend	BLH 30 – 45 Blende 2-teilig 30-45° mit Hinterlüftung 125 mm umlaufend	2250-Ø-BLHxx-XX
		80	59,20	62,20	65,30	face plate with ventilation plaque pare-feu, demi-ronde, prière de préciser la pente en degrés de votre toiture Rivestimento diviso in due retroventilato avvolgente 0°-15° / 15°-30° / 30° - 45° tweedelige afschermplaat belucht omlopend, 0°-15° / 15°-30° / 30° - 45° Защитный лист для прохода через стену с подачей воздуха
		100	59,20	62,20	65,30	
		113	59,20	62,20	65,30	
		130	59,20	62,20	65,30	
		150	59,20	62,20	65,30	
		160	59,20	62,20	65,30	
		180	59,20	62,20	65,30	
		200	59,20	62,20	65,30	
		250	59,20	62,20	65,30	
		300	69,30	72,80	76,40	
		350	81,40	85,40	89,70	
		400	90,90	95,50	100,30	
450	105,40	110,70	116,20			
500	115,20	120,90	127,00			

Blitzschutzklemme		Technische Daten		Lg*	Preis	2250-Ø-BK
		Ø d	Ø D	kg	EUR	bracket for flash security bride paratonnerre fascetta per cavo tirante brandbeschermingsklem Хомут для крепления молнеотвода
		80	140	-	18,10	
		100	163	-	18,10	
		113	163	-	18,10	
		130	180	-	18,90	
		150	200	-	19,50	
		160	213	-	19,50	
		180	230	-	20,10	
		200	250	-	20,10	
		250	300	-	20,80	
		300	350	-	23,80	
		350	400	-	27,20	
400	450	-	30,10			
450	500	-	36,30			
500	550	-	46,20			

Dreipunktbefestigung für Seilabspannung (ohne Seil)		Technische Daten		Lg*	Preis	2250-Ø-SA
		Ø d	Ø D	kg	EUR	bracket for static wires bride de haubannage avec 3 points de fixation fascetta per 3 cavi tiranti tuidraden spanband met drie puntsbevestiging Хомут с отверстиями для троса
		80	140	-	32,30	
		100	163	-	33,50	
		113	163	-	33,50	
		130	180	-	34,90	
		150	200	-	34,90	
		160	213	-	35,30	
		180	230	-	35,60	
		200	250	-	36,20	
		250	300	-	37,60	
		300	350	-	38,20	
		350	400	-	38,50	
400	450	-	39,10			
450	500	-	39,70			
500	550	-	40,30			

*Lg=Legierungsgewicht: Lg (in kg) x Faktor Legierungszuschlag (in €/kg) = Netto-Aufpreis Legierungszuschlag

Doppelwandiges Schornsteinsystem eka complex D

Isolierdicke 30 mm Ø 80 - 100 mm
Isolierdicke 25 mm ab Ø 113 mm



Teleskopstange verstellbar bis 3 m (2 Stück)		Technische Daten	Lg*	Preis	1000-000-TS1 1000-000-TS3
	TS1 verstellbar 800-1500 	TS1	kg	EUR	telescoping rod for lengths up to 1,5 / 3,0 m, 2St. Barre télescopique 1,5 / 3,0 m, 2St. Asta telescopica regolabile fino a 1,5 / 3 m, 2St. telescopische stang verstellbaar tot 1,5 / 3 m, 2St. Телескопическая опора -раздвижная до 1,5 / 3 м, 2Ст.
	TS3 verstellbar 1600-3000 	TS3	-	310,00	

Dachhaken für Teleskopstange (2 Stück)		Technische Daten	Lg*	Preis	1000-000-DA 1000-000-DAD
Typ DA Typ DAD 	 	Typ DA	kg	EUR	roof hook crochet de couvreur aripone pertetto dak haak крюк в крыше для приставной лестницы
		Typ DAD	-	87,40	

Deflektorhaube		Technische Daten	Lg*	Preis	2250-Ø-DH		
		Ød		kg	EUR	deflector chapeau déflecteur deflettore deflektorkap Кожух дефлектора	
		80	140	410	1,47		381,80
		100	163	480	2,03		393,50
		113	163	480	2,16		393,50
		130	180	510	2,58		414,10
		150	200	540	3,08		444,90
		160	213	550	3,34		462,10
		180	230	600	4,00		480,40
		200	250	620	4,54		512,90
		250	300	700	6,27		611,80
		300	350	780	8,25		765,10
		350	400	860	10,50		837,60
400	450	940	13,00	952,70			
450	500	1020	15,46	1061,80			
500	550	1100	17,09	1421,90			

Stützfuß 1000 - 1750 mm mit Schale		Technische Daten	Lg*	Preis	2250-Ø-SP1 2250-Ø-SP2
 Ausführung mit Gegenschale: Aufpreis: 15%		Ø d	kg	EUR	support pied d'appui avec support demi-rond supporto 600 - 1000 mm 1000 - 1750 mm steunvoet 600 - 1000 mm 1000-1750 mm met schaal Опора 600 - 1000 mm 1000 - 1750 mm
		SP1			
		80 - 250	-	130,10	
		300 - 500	-	140,20	
		SP2			
		80 - 250	-	193,60	
		300 - 500	-	207,60	

*Lg=Legierungsgewicht: Lg (in kg) x Faktor Legierungszuschlag (in €/kg) = Netto-Aufpreis Legierungszuschlag

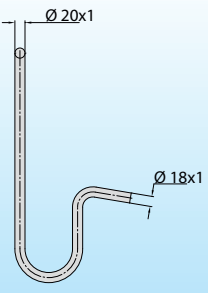
Winkelsyphon	Technische Daten	Lg*	Preis	1000-000- WSD
 <p>max. 200 Pa</p>	 <p>Ø 20x1 Ø 18x1</p>	kg	EUR	syphon (revolving)
		-	55,40	syphon (tourner)
				sifone (rivolgere)
				hoeksifon draaibaar
				Угловой сифон

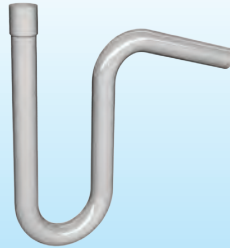
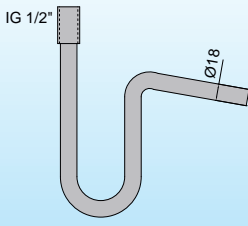
Winkelsyphon mit 1/2" Innengewinde senkrecht	Technische Daten	Lg*	Preis	1000-000-WS1/2S
 <p>max. 200 Pa</p>	 <p>IG 1/2" Ø 18</p>	kg	EUR	syphon (revolving)
		-	77,30	syphon (tourner)
				sifone (rivolgere)
				hoeksifon draaibaar
				Угловой сифон

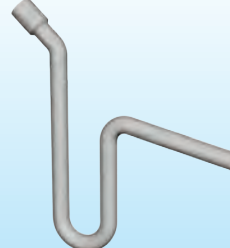
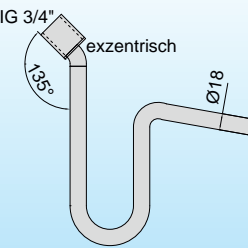
Winkelsyphon mit 3/4" Innengewinde unter 45° für Schalldämpfer	Technische Daten	Lg*	Preis	1000-000- WSA
 <p>max. 200 Pa</p>	 <p>IG 3/4" exzentrisch 135° Ø 18</p>	kg	EUR	syphon (revolving)
		-	88,20	syphon (tourner)
				sifone (rivolgere)
				hoeksifon draaibaar
				Угловой сифон

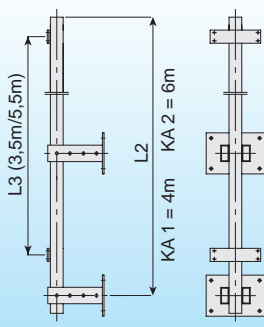
Kragarm	Technische Daten	Lg*	Preis	1000-Ø-KRAG	
	 <p>L3 (3,5m/5,5m) L2 KA 1 = 4m KA 2 = 6m</p>	kg	EUR	long arm support	
		verzinkt	-	auf Anfrage	mat de fixation déporté
		Edelstahl	-	auf Anfrage	supporto per camino
				krachtarm	
				Опора для раструбы	

*Lg=Legierungsgewicht: Lg (in kg) x Faktor Legierungszuschlag (in €/kg) = Netto-Aufpreis Legierungszuschlag

Doppelwandiges Schornsteinsystem eka complex D

Isolierdicke 30 mm Ø 80 - 100 mm
Isolierdicke 25 mm ab Ø 113 mm





Isolationsbogen zweiteilig für Pelletöfen		Technische Daten		Lg*	Preis	2250-Ø-IB90	
		Ø d	Ø D	a	kg	EUR	elbow 90°
		80	140	130	1,56	171,30	coude 90°
		100	163	140	1,90	174,80	gomito 90°
		113	163	146	2,00	176,00	bocht 90°
		130	180	155	2,31	198,10	Отвод 90°



Bodenplatte Zwischenstütze für Schacht L 90		Technische Daten		Lg*	Preis	2250-Ø-BPZL90	
		Ø d	Ø D	A**	kg	EUR	intermediate plate
		80	140	170	0,97	68,30	plaque de base intermédiaire
		100	163	180	1,04	71,00	piastra di partenza con raccogli condensa
		113	163	180	1,04	71,00	bodenplaat voor tussensteunen
		130	180	200	1,18	73,50	Напольная плита для промежуточной опоры
		150	200	220	1,33	74,10	
		160	213	230	1,56	74,80	
		180	230	270	1,60	76,00	
		200	250	270	1,72	79,30	
		250	300	330	2,12	107,70	
300	350	370	2,55	118,30			

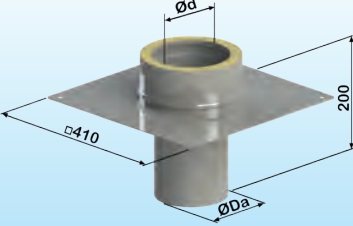

***) Empfohlene Schachtmaße innen für Unterdruckbetrieb

Schachtmaß innen: NW Abgasrohr + 70 mm (min) bei Unterdruckbetrieb
NW Abgasrohr + 100 mm (min) bei Überdruckbetrieb

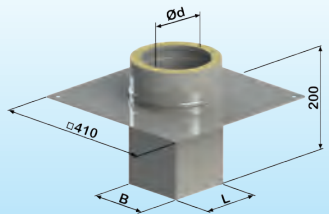
*Lg=Legierungsgewicht: Lg (in kg) x Faktor Legierungszuschlag (in €/kg) = Netto-Aufpreis Legierungszuschlag

Schornsteinkopferhöhung mit Klemmbandstutzen Einschub rund	Technische Daten				Preis		2250-Ø-BPZKE-R
 <p>Einschub rund 200 mm tief</p>	Ø d	Ø Da		Lg*	EUR	 chimney head elevation round  Extension tête de cheminée - rond	
	130	125		2,35	108,70		
	150	145		2,72	111,30		
	160	155		2,90	112,60		
	180	175		3,27	115,10		
	200	195		3,64	118,20		

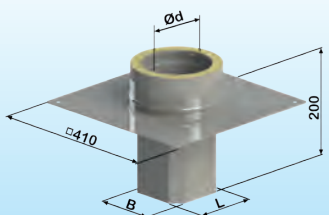
Schornsteinkopferhöhung mit Klemmbandstutzen Einschub eckig	Technische Daten				Preis		2250-Ø-BPZKE-E
 <p>Einschub eckig 200 mm tief</p>	Ø d	L	B	Lg*	EUR	 chimney head elevation angular  Extension tête de cheminée - carrée	
	130	125	125	2,64	122,40		
	150	145	145	3,05	125,60		
	160	155	155	3,26	127,00		
	180	175	175	3,67	130,00		
	200	195	195	4,07	133,60		

Schornsteinkopferhöhung mit Klemmbandstutzen Einschub mit angekanteten Ecken	Technische Daten				Preis		2250-Ø-BPZKE-AE
 <p>Einschub mit angekanteten Ecken 200 mm tief</p>	Ø d	L	B	Lg*	EUR	 chimney head elevation rounded corners  Extension tête de cheminée - avec coins arrondis	
	130	125	125	2,64	127,80		
	150	115	175	3,05	125,60		
	150	145	145	3,05	131,00		
	160	155	155	3,26	132,40		
	180	135	195	3,27	129,00		
	180	175	175	3,67	135,40		
	200	195	195	4,07	139,00		

Weitere Maße und Preis auf Anfrage.

Doppelwandiges Schornsteinsystem eka complex D

Isolierdicke 30 mm Ø 80 - 100 mm
Isolierdicke 25 mm ab Ø 113 mm



HINWEISE FÜR SPEZIELLE AUSFÜHRUNGEN:

- Beim Betrieb von Heizkesseln ist sicherzustellen, daß keine FCKW-haltigen Bestandteile in die Verbrennungsluft gelangen können. Siehe hierzu auch das BDH-Informationsblatt Nr. 1 „Korrosion durch Halogenkohlenwasserstoffe“
- Bei der Errichtung von Edelstahl-Abgasanlagen im Küstengebiet (bis ca. 50 km von der Küste) kann die Außenschale durch salzhaltige Meeresluft optisch beeinträchtigt werden. Es ist daher eine Ausführung mit Pulverbeschichtung (RAL-Farbe) empfehlenswert.

SONSTIGE HINWEISE:

Bauteile für Wanddurchführungen finden Sie im eka-Prospekt PS218 „Wand-, Decken- und Dachdurchführungen“.

HINWEISE ZUR PFLEGE:

Wir empfehlen in vierteljährlichen Abständen die Pflege des Edelstahlprodukts (z.B. Abwaschen mit klarem Wasser). Diese dient der optischen und hygienischen Oberflächenbehandlung zur Werterhaltung.

Wichtig ist dies vor allem in Küstennähe und Industrieumgebungen bzw. überall dort, wo es zu Aufkonzentration von Chloriden und Schwefeldioxid kommen kann.

Technische Änderungen vorbehalten.